

Česlava Celitāne

Krāso! Runā! Raksti!

Darba lapas 5-6 gadus veciem bērniem

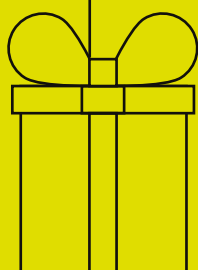

Dizains: Santa Celitāne

**Mācību līdzekļa
"Krāso! Runā! Raksti!"
saturs**

1. nodaļa. Cāļus skaita rudenī	10
1.1. Kas es esmu? Kas tu esi? _____	1.–5. darba lapa
1.2. Cik smaržīgs? Laikam garšīgs _____	6.–10. darba lapa
2. nodaļa. Ka notiek rudenī?	20
2.1. Uz siltajām zemēm _____	11.–15. darba lapa
2.2. Krāsainais rudens _____	16.–20. darba lapa
3. nodaļa. Cik daudz svētku!	30
3.1. Mārtiņi klāt! _____	21.–25. darba lapa
3.2. Mana vārda diena! _____	26.–30. darba lapa
4. nodaļa. Gaismas laiks	40
4.1. Nāk rūķītis ar dāvanu maisu _____	31.–35. darba lapa
4.2. Eglītes stāsts _____	36.–40. darba lapa
5. nodaļa. Ieejam jaunā gadā!	50
5.1. Diena un nakts _____	41.–45. darba lapa
5.2. Divpadsmit mēneši _____	46.–53. darba lapa
6. nodaļa. Garajos ziemas vakaros	63
6.1. Pasaku laiks _____	54.–57. darba lapa
6.2. Mani mīļākie pasaku varoņi _____	58.–62. darba lapa
7. nodaļa. Pavasaris jau nāk!	72
7.1. Zoológiskajā dārzā _____	63.–67. darba lapa
7.2. Lieldienu laiks _____	68.–72. darba lapa
8. nodaļa. Zaļais laiks	82
8.1. Visas bučas mammai _____	73.–78. darba lapa
8.2. Tiekamies Latvijā! _____	79.–82. darba lapa

Metodiskie norādījumi skolotājam

Skolotāj!

Katrs izpildīts uzdevums ir jūsu bērna / audzēkņa maza uzvara.

Izpildītu uzdevumu var novērtēt ar jauku attēlu – zīmi darbības lapas augšējā stūrī.



• Ja bērns veiksmīgi, kārtīgi un patstāvīgi ir ticis galā ar uzdevumu – skolotājs izkrāso / apvelk lielāku no attēliem - **malacis!**



• Ja bērnam bija grūtības ar uzdevuma pildīšanu, bija nepieciešama skolotāja palīdzība, jāmācās strādāt kārtīgi – skolotājs iezīmē / izkrāso mazāku no attēliem – **nākamreiz pacenties vairāk!**

Jebkurā gadījumā, pat ja rezultāts nav tik labs, kā gribētos skolotājam, paslavējiet bērnu par darbu!

Lai izdodas!

1. darba lapa

• Izkrāso portretus!

Viens ir tavš portrets, otrs – tava drauga/tavas draudzenes.

• Stāsti!

Kas tu esi?

Kā tevi sauc?

Cik tev gadu?

Vai tu esi liels / liela?

Kas tev ir? (Ķermeņa daļas)

Kur tu dzīvo?

• Savieno meitenes ķermeņa daļu nosaukumus ar attiecīgu zīmējuma daļu!

2. darba lapa

• Uzzīmē savu un sava brāļa / savas māsas / drauga / draudzenes noskaņojumu!

• Pabeidz zīmēt! Uzzīmē otru pusi! Izkrāso!

• Stāsti!

Vai tu esi cilvēks?

Vai tu esi bērns?

Vai tev ir brālis / māsa?

Vai tu esi labs / laba, slikts / slikta?

Vai tu esi priecīgs / priecīga, skumjš / skumja?

• Parādi zīmējumā, kur ir tavas acis, ausis, kājas rokas, mati!

Kur ir mute, deguns, galva?

• Savieno ķermeņa daļu nosaukumus ar attiecīgu daļu zīmējumā!

3. darba lapa

• Izkrāso!

• Pa punktēto līniju savieno attēlus!

• Nosauc visu, kas ir uzzīmēts!

Saki tā: bērns – bērni, zēns – zēni, ...

4. darba lapa

• Aplūko portretus un nosauc ģimenes locekļus!

• Izgriez portretus un ielīmē mājas lodziņos!

• Izkrāso māju!

• Stāsti!

Kas ir tavā ģimenē?

Kas tev ir?

Kā sauc tavu mammu / tēti / brāli / māsu?

5. darba lapa

• Aplūko un nosauc ķermeņa daļas!

• Nosaki vārda pirmo skaņu! Lodziņā izkrāso atbilstošo burtu!

6. darba lapa

• Apvelc kontūru un izkrāso!

• Nosauc dārzenus!

• Savelc līnijas! Ar sarkanu zīmuli atzīmē, kas pieder pie meitenēm, ar zilu – pie zēniem.

Saki tā: Tas ir ... (kartupelis / sīpols, ...).

Tā ir ... (biete).

• Stāsti!

Kādā krāsā ir ... (tomāts, gurķis, ...)?

Kas ir sarkans / sarkana, zaļš / zaļa, ...?

Kas ir apaļš / apaļa, ovāls / ovāla?

Kur aug ...?

7. darba lapa

• Izkrāso dārzenus!

• Pa punktēto līniju savieno attēlus!

• Nosauc visu, kas ir uzzīmēts!

Saki tā: biete – bietes, burkāns – burkāni, ...

• Stāsti!

Kur aug ... ?

Vai ... aug dārzā?

Vai ... ir gatavi / gatavas?

Kas aug rudenī?

Vai ... aug rudenī?

8. darba lapa

• Izkrāso un nosauc augļus!

• Savelc līnijas un stāsti!

Kas tev garšo / negaršo?

• Stāsti!

Kādā krāsā ir ... ?

Kas ir zaļš / dzeltens / ... ?

Vai ... ir sarkans / sarkana, dzeltens / dzeltena, ...?

Kas ir apaļš / apaļa, ovāls / ovāla?

Vai ... ir apaļš / apaļa, ovāls / ovāla?

9. darba lapa

- Izkrāso augļus!
- Savieno saderīgos attēlus!
- Nosauc vienu augli un daudzus!
- Stāsti!
Vai tas / tā ir ... ?
Vai tie / tās ir ... ?
Kādā krāsā ir ... ?
Vai ... ir sarkani / sarkanas/
Vai ... ir gatavi / gatavas?
Kas tev garšo?
Vai tev garšo ... ?

10. darba lapa

- Izkrāso ogas!
- Savieno saderīgos attēlus!
- Nosauc vienu ogu un daudzas ogas!
- Stāsti!
Vai tas / tā ir ... ?
Vai tie / tās ir ... ?
Kādā krāsā ir ... ?
Kas tev garšo?
Kas ir gatavi / gatavas?
Kur aug ... ?
Kas aug rudenī?

11. darba lapa

- Aplūko un nosauc putnus!
- Ar sarkanu zīmuli savieno vajadzīgo ar meitenes siluetu, ar zilu zīmuli – ar zēna siluetu!
Saki tā: Tas ir stārķis / gulbis / zvirbulis.
Tā ir dzērve / zīlīte.
- Stāsti!
Vai tas / tā ir ... ?
Vai ... ir liels / liela, mazs / maza?
Ko dara putni? (Lido, aizlido, dodas prom)
Vai ... lido / aizlido / dodas prom?
Vai ... ir spārni / knābis?

12. darba lapa

- Aplūko un nosauc putnus!
- Savieno putna attēlu ar tā ēnu!
- Stāsti!
Vai tas / tā ir ... ?
Kāds / kāda ir ... ?
Kāds ir ... knābis?
Kādi ir ... spārni?
Kurš putns tev patīk?

13. darba lapa

- Savieno saderīgos attēlus!
- Nosauc vienu putnu un daudzus putnus!
- Stāsti!
Kādi / kādas ir ... ?
Kurš putns / kuri putni tev patīk?

14. darba lapa

- Izkrāso sniegpārslīņu, palmu un sauli!
- Nosauc un izkrāso putnus!
- Savelc līnijas – kuri putni pārziemo pie mums, kuri – aizlido uz siltajām zemēm!
- Stāsti!
Kuri putni aizlido uz siltajām zemēm?
Kuri putni paliek Latvijā?

15. darba lapa

- Nosauc attēlus!
- Palīdzi stārķim atrast ceļu līdz ligzdai! Pārvelc ar krāsainu zīmuli!
- Izkrāso attēlus un papildini zīmējumu!

16. darba lapa

- Izkrāso kokus! Nosauc tos!
- Ar sarkanu zīmuli savieno attiecīgus kokus ar meitenes siluetu, ar zilu zīmuli – attiecīgus kokus ar zēna siluetu!
Saki tā: Tas ir bērzs / ozols.
Tā ir egle / priede / liepa / kļava.
- Stāsti!
Vai tas / tā ir ... ?
Kur aug ... ? (Mežā, parkā)

17. darba lapa

- Izkrāso kokus rudens krāsās! Nosauc tos!
- Savieno kokus ar atbilstīgām lapām un skujujām!
- Stāsti!
Kādi koki aug mežā / parkā?
Kuram kokam ir zīles / skujas / lapas?

18. darba lapa

- Izkrāso kokus!
- Savelc saderīgos!
- Nosauc vienu koku un daudzus!
Saki tā: Tas ir koks / ozols / bērzs.
Tie ir koki / ozoli / bērzi.
Tā ir liepa / kļava / priede.
Tās ir liepas / kļavas / priedes.
- Stāsti!
Vai tas / tā / tie / tās ir ... ?
Kādi ir koki rudenī? (Krāsaini)

19. darba lapa

- Izkrāso vienādas lapas un skujas vienādi!
- Nosaki, kuram kokam tas pieder!
- Parādi! Kur ir bērza lapas / ozola lapas / kļavas lapas / egļu skujas / priežu skujas?
- Stāsti!
Kādas ir koku lapas / skujas rudenī?
Kādā krāsā ir lapas / skujas?
Ko dara lapas rudenī? (Krīt / virpuļo)

20. darba lapa

- Nosauc attēlus!
- Katrā rindā atrodi neiederīgo! Izkrāso to!

21. darba lapa

- Kādi svētki ir rudenī? (Mārtiņdiena)
- Kad svin Mārtiņdienu? (10.novembrī)
- Izkrāso gaili norādītajās krāsās!
- Stāsti!
Kas tas ir?
Vai tas ir ... ?
Kādas ķermeņa daļas ir gailim?
Vai gailim ir .. ?
- Uzzīmē gailim graudiņus!
- Papildini zīmējumu!

22. darba lapa

- Izkrāso!
- Skaiti! Saki tā: viens gulbis – viena zilīte, divi citroni – divas rokas utt.
- Skaiti to, kas ir kreisajā pusē: viens, divi, trīs, četri, pieci.
- Skaiti to, kas ir labajā pusē: viena, divas, trīs, četras, piecas.
- Salīdzini: viens – viena, divi – divas utt.
- Saskaiti lietas, kas tev apkārt!

23. darba lapa

- Izkrāso!
- Skaiti: seši ķirši – sešas bietes, septiņi gurķi – septiņas avenes utt.
- Skaiti to, kas ir kreisajā pusē: seši, septiņi utt.
- Skaiti to, kas ir labajā pusē: sešas, septiņas utt.
- Salīdzini: seši – sešas, septiņi – septiņas utt.
- Skaiti lietas, kas tev apkārt!

24. darba lapa

- Izkrāso un nosauc attēlus!
- Savieno ciparu ar atbilstošo attēlu!
- Skaiti to, kas pieder pie „zēniem” – viens zēns, divi bērzi, trīs tomāti utt.
- Skaiti to, kas pieder pie „meitenēm” – viena meitene, divas egles utt.

25. darba lapa

- Aplūko tirgu / tirdziņu! Izkrāso!
- Stāsti!
Ko pārdod tētis?
Ko saka tētis? (Es pārdodu ...)
Ko pērk mamma?
Ko stāsta mamma? (Es pērku ...)
Vai tētīm ir ... (bietes, sīpoli, ...)?
Vai mammai grozā ir ... ?

26. darba lapa

- Izrotā torti ar sava vārda pirmo burtu!
- Izkrāso un izgriez ogas un augļus!
- Izrotā svētku torti ar ogām un augļiem! Nosauc tos!
- Stāsti!
Kā tevi sauc?
Kāds ir tavs uzvārds?
Kurus svētkus tu svini?
Kad ir tava vārdadiena?
Kāda ir torte?

27. darba lapa

- Aplūko un izkrāso vārdadienas dāvanas!
- Ko tu gribi saņemt vārdadienā? Savieno!
- Stāsti!
Kas tas / tā ir ?
Vai tas / tā ir ... ?
Kas tev patīk?

28. darba lapa

- Katrā rindā atrodi divus vienādus zīmējumus!
Izkrāso tos vienādi!

29. darba lapa

- Pa norādītajām līnijām izgriez galda karti un apsveikumu!
- Izkrāso!
- Galda kartē ieraksti / noraksti sava ciemiņa vārdu!
- Pēc dotā parauga uztaiši galda kartes vajadzīgā skaitā (visiem ciemiņiem)!
- Apsveikumā ieraksti / noraksti savu vārdu!

30. darba lapa

- Ar atšķirīgiem krāsainiem zīmuļiem pārzīmē līnijas un uzzini, kādas dāvanas sagādāja bērni!

31. darba lapa

- Izkrāso un nosauc attēlus!
- Savieno attēlus ar attiecīgu zēna vai meitenes siluetu!
- Stāsti!
Kuri svētki drīz būs? (Ziemassvētki)
Ko tu vēlies saņemt Ziemassvētkos? (Dāvanu)
Kāda ir dāvana? (Liela / maza / skaista)
Vai tas / tā ir ... ?
Kas tev patīk?
Vai tu esi priecīgs / priecīga?

32. darba lapa

- Izkrāso un nosauc attēlus!
- Stāsti!
Kuri svētki drīz būs? (Ziemassvētki)
Kāds tu esi? (Priecīgs)
Vai bērni ir priecīgi?
Vai tas / tā ir ... ?
Kurš no šiem attēliem tev patīk?

33. darba lapa

Uzmanīgi aplūko dāvanas! Atrodi vienādas!

- Vienādās dāvanas iesvītro vienādi!
- Stāsti!
 - Kurus svētkus mēs svinam?
 - Vai bērni ir priecīgi?
 - Kāds tu esi?
 - Ko tev uzdāvināja / uzdāvinās?
 - Kāda ir dāvana?

34. darba lapa

- Kas te uzzīmēts?
- Izkrāso laukumus, kuros ir punktiņš!
- Stāsti!
 - Kurus svētkus mēs svinam ziemā?
 - Kāds tu esi?
 - Ko tu dāvini / dāvināsi?
 - Ko tu saņem / saņemsi?
 - Kāda ir dāvana?

35. darba lapa

- Katrā rindā atrodi divus vienādos!
- Izkrāso tos vienādi!
- Nosauc attēlus!
- Stāsti!
 - Vai tas / tā ir ... ?
 - Vai tie / tās ir ... ?
 - Vai tev patīk Ziemassvētki?
 - Vai tev patīk dāvanas?
 - Ko tev uzdāvināja?
 - Kas tev patīk?

36. darba lapa

- Izkrāso un nosauc attēlus!
- Stāsti!
 - Kas tas / tā ir?
 - Vai tas / tā ir ... ?
 - Kuri svētki ir atnākuši?

37. darba lapa

- Piezīmē otru pusi! Uzzīmē rotājumus!
- Stāsti!
 - Kas tā ir?
 - Kāda ir eglīte? (Zaļa / maza / liela / kupla.)
 - Vai eglei ir skujuas?
 - Vai tev mājās ir / būs eglīte?
 - Vai tev būs liela / maza eglīte?
 - Kas pušķos eglīti? (Es, mamma, tētis, brālis, māsa, visa ģimene.)

38. darba lapa

- Izkrāso un nosauc attēlus!
- Stāsti!
 - Vai tas / tā ir ... ?
 - Kurš no šiem attēliem tev patīk?
 - Kuri svētki ir atnākuši?
 - Kādi ir bērni? (Priecīgi)

39. darba lapa

- Vienādas svecītes iesvītro vienādi!
- Stāsti!
 - Kuri svētki ir ziemā?
 - Vai bērni ir priecīgi?
 - Kāds tu esi? (Priecīgs.)
 - Ko dara sveces? (Deg.)
 - Vai tev patīk sveces?

40. darba lapa

- Saskaiti un savieno ar atbilstošo skaitli!
- Skaiti tā: viens lācis, divi rotājumi utt. viena egle, divas sniegpārslas utt.
- Izkrāso!

41. darba lapa

- Aplūko un izkrāso diennakts daļas!
- Stāsti!
 - Kas tas / tā ir? (Rīts, diena, vakars, nakts)
 - Vai tas / tā ir ... ?
 - Kāds ir rīts / vakars? (Tumšs / gaišs)
 - Kāda ir diena / nakts? (Tumša / gaiša)

42. darba lapa

- Nosaki diennakts daļu! Izkrāso!
- Stāsti!
 - Ko tu dari no rīta?
- Iezīmē pulksteņa rādītājus! Cik ir pulkstenis, kad tu pamosties / kad tu ej uz skolu / bērnudārzu?

43. darba lapas

- Nosaki diennakts daļu! Izkrāso!
- Stāsti!
 - Ko tu dari dienā?
- Iezīmē pulksteņa rādītājus! Cik ir pulkstenis, kad tu pusdieno / dejo?

44. darba lapa

- Nosaki diennakts daļu! Izkrāso!
- Stāsti!
 - Ko tu dari vakarā?
- Iezīmē pulksteņa rādītājus! Cikos tu vakariņo / ej gulēt?

45. darba lapa

- Izkrāso savas nodarbes!
- Aplūko pulksteņus! Cik ir pulkstenis, kad tu pamosties / pusdieno utt.?
- Iezīmē pulksteņa rādītājus!
- Stāsti!
 - Cikos tu pamosties / pusdieno utt.?

46. darba lapa

- Kurš gadalaiks attēlots zīmējumā?
- Papildini zīmējumu ar savām sniegpārslīņām un kupenām!
- Noraksti gadalaika nosaukumu!
- Izkrāso!
- Nosauc pazīstamas lietas un parādības!
- Stāsti!
 - Kas tas / tā ir?
 - Vai tas / tā ir ... ?
 - Vai tev patīk ziema?
 - Nosauc ziemas mēnešus!

47. darba lapa

- Kurš gadalaiks attēlots zīmējumā?
- Papildini zīmējumu ar saules stariņiem, ziedīņiem ābelē un mazajām lapiņām!
- Noraksti gadalaika nosaukumu!
- Izkrāso!
- Nosauc pazīstamas lietas un parādības!
- Stāsti!
 - Kas tas / tā ir?
 - Vai tas / tā ir ... ?
 - Vai tev patīk pavasaris?
 - Nosauc pavasara mēnešus!

48. darba lapa

- Aplūko attēlu un nosauc gadalaiku!
- Papildini zīmējumu ar puķītēm, taureņiem un saules stariņiem!
- Noraksti gadalaika nosaukumu!
- Izkrāso!
- Nosauc pazīstamas lietas un parādības!
- Stāsti!
 - Kas tas / tā ir?
 - Vai tas / tā ir ... ?
 - Vai tev patīk vasara?
 - Nosauc vasaras mēnešus!

49. darba lapa

- Aplūko un nosauc gadalaiku!
- Papildini zīmējumu ar sēnītēm, rudens lapām, āboliem, lietutiņu!
- Noraksti gadalaika nosaukumu!
- Izkrāso!
- Nosauc pazīstamas lietas un parādības!
- Stāsti!
 - Kas tas / tā ir?
 - Vai tas / tā ir ... ?
 - Vai tev patīk rudens?
 - Nosauc rudens mēnešus!

50. darba lapa

- Kuri gadalaiki attēloti zīmējumos?
- Savieno attēlus ar atbilstošajiem gadalaiku nosaukumiem!
- Izkrāso!
- Stāsti!

Kas tas / tā ir?
 Vai tas / tā ir ... ?
 Nosauc pēc kārtas visus gadalaikus!
 Kurš gadalaiks atnāk / aiziet?
 Kurā gadalaikā tev ir dzimšanas diena / vārdadiena?

51. darba lapa

- Apvelc mākoņu kontūras!
- Ieraksti trūkstošus kārtas skaitļu ciparus!
- Skaiti mākoņus!
 - Saki tā: pirmais, otrais, trešais, utt.
- Izkrāso!

52. darba lapa

- Aplūko un nosauc gadalaikus!
- Savieno ar līnijām mēnešu nosaukumus ar attiecīgu gadalaiku!
- Nosauc pēc kārtas visus gadalaikus!
- Nosauc mēnešus katrā gadalaikā!
- Stāsti!
 - Kas tas / tā ir? (Gadalaiku nosaukumi)
 - Vai tas / tā ir ... ? (Gadalaiku nosaukumi)
 - Kurā gadalaikā / mēnesī ir tava dzimšanas diena / vārdadiena?

53. darba lapa

- Aplūko mājiņas!
- Kurā mājiņā dzīvo ziemas / pavasara / vasaras / rudens mēneši?
- Izgriez mēnešu nosaukumus! Katrai mēnešu grupai atrodi savu mājiņu un ielīmē to!
- Stāsti!
 - Ziemas mēneši ir
 - Pavasara mēneši ir
 - Vasaras mēneši ir
 - Rudens mēneši ir
 - Kurā mēnesī ir tava dzimšanas diena / vārdadiena?

54. darba lapa

- Nosauc pasaku varoņus!
- Nosaki katra vārda pirmo un pēdējo skaņu!
- Stāsti!
 - Kas tas / tā ir?
 - Kas tev patīk?
 - Vai tev patīk ...?
 - Vai tev patīk pasakas?
 - Vai tu proti lasīt?
 - Vai tu lasi pasakas?
 - Kas tev lasa pasakas priekšā?

55. darba lapa

- Pabeidz zīmēt! Izkrāso!
- Papildini zīmējumu!
- Stāsti!
 - Kāda ir princese?
 - Kādi mati / kādas acis / kāda kleita ir princesei?

56. darba lapa

- Apvelc burtus!
- Ieraksti lodziņos trūkstošus burtus un izlasi vārdus!
- Izkrāso burtus un zīmējumus!

57. darba lapa

- Pabeidz apakšējo zīmējumu tā, lai tas būtu tāds pats kā augšējais!
- Izkrāso abus zīmējumus!

58. darba lapa

- Nosauc pasaku varoņus!
- Nosaki katra vārda pirmo un pēdējo skaņu!
- Izkrāso!
- Stāsti!
Kas tas / tā ir?
Vai tas / tā ir ...?
Kas ir liels / mazs / drosmīgs / viltīgs / skaists / slikts / jauns?
Kas tev patīk?
Vai tev patīk ...?
Vai tev patīk pasakas?
Vai tu proti lasīt?
Vai tu lasi pasakas?
Kas tev lasa pasakas priekšā?

59. darba lapa

- Nosauc pasaku varoņus!
- Katram pasakas varonim atrodi viņa ēnu! Savieno un izkrāso!
- Stāsti!
Kas tas / tā ir?
Vai tas / tā ir ...?
Kas ir liels / mazs / drosmīgs / viltīgs / skaists / slikts / jauns?
- Salīdzini!
Kas tev patīk?
Kas tev patīk vislabāk?

60. darba lapa

Savelc saderīgos attēlus! Izkrāso!

- Nosauc vienu un daudzus!
Saki tā: Tas ir vilks. Tie ir vilki.
Tā ir lapsa. Tās ir lapsas.

61. darba lapa

- Atšifrē vārdus un uzraksti tos pareizi!
- Izkrāso!

62. darba lapa

- Viens attēls atšķiras no pārējiem. Kurš tas ir? Izkrāso to!
- Stāsti!
Kas tas / tā ir?
Vai tas / tā ir ...?
Kas tev patīk?
Kas tev patīk vislabāk?
Vai tev patīk ...?
Kāds ir rūķis / Sprīdītis?
Kāda ir princese?

63. darba lapa

- Nosauc dzīvniekus un izkrāso!
- Iezīmē aplišos, kuri dzīvnieki tev patīk / nepatīk?
- Stāsti!
Kas tas / tā ir?
Kurš dzīvnieks tev patīk / nepatīk?
Ko tu redzi?
Kāds / kāda viņš / viņa ir?
Kas viņam / viņai ir?
Kuram dzīvniekam ir asi zobi / lielas ausis / gara mēle?
Ko dara lauva / čūska?

64. darba lapa

- Nosauc dzīvniekus un izkrāso!
- Iezīmē aplišos, kuri dzīvnieki tev patīk / nepatīk?
- Stāsti!
Kas tas / tā ir?
Vai tas / tā ir ...?
Ko tu redzi?
Kurš dzīvnieks tev patīk / nepatīk?
Kāds / kāda viņš / viņa ir?
Kas viņam / viņai ir?
Kuram dzīvniekam ir asi zobi / garš kakls / gara aste / garas kājas?
Ko dara ...?

65. darba lapa

- Savieno saderīgos attēlus! Izkrāso!
- Nosauc vienu dzīvnieku un daudzus!
Saki tā: Tas ir krokodils - tie ir krokodili.

66. darba lapa

- Nosauc dzīvniekus! Nosaki katra vārda pirmo un pēdējo skaņu!
- Izkrāso!
- Savieno dzīvnieka attēlu ar tā ēnu!
- Stāsti!
Vai tas / tā ir...?
Ko tu redzi?
Kāds / kāda viņš / viņa ir?
Kas viņam / viņai ir?
Kuram dzīvniekam ir asi zobi / lielas ausis / gara mēle / garš kakls / garas kājas?
Kurš dzīvnieks tev patīk?

67. darba lapa

- Izkrāso un nosauc burtus!
- Nosauc dzīvniekus! Kuri vārdi sākas ar L un K? Savieno ar attiecīgo burtu!
- Kuros vārdos ir skaņa R? Savieno!

68. darba lapa

- Nosauc attēlus un noraksti vārdus!
- Izkrāso!
- Stāsti!
Kas tas / tā ir?
Vai tas / tā ir ...?
Kas tev patīk?
Kad svin Lieldienas?

69. darba lapa

- Savieno vienāda lieluma olas!
- Vienādās olas iesvītro vienādi!
- Stāsti!
Kurus svētkus svin pavasarī?
Ko dara Lieldienās? (let uz baznīcu, šūpojas, krāso olas, ripina olas, meklē olas)
Vai tev patīk krāsot olas?

70. darba lapa

- Izrotā Lieldienu olas!
- Stāsti!
Kad svin Lieldienas?
Ko tu dari Lieldienās? (Krāsoju olas, ripinu olas, meklēju olas, šūpojos)
Vai tev patīk krāsot olas / ripināt olas / meklēt olas / šūpoties?

71. darba lapa

- Pabeidz zīmēt!
- Stāsti!
Kurus svētkus svin pavasarī?
Ko dara Lieldienās?
Vai tev patīk Lieldienas?

72. darba lapa

- Atrodi 4 neprecizitātes ūdens atspulgā!
- Izkrāso visu, kas ir krastā!
- Stāsti!
Ko tu redzi?
Kas ir zaķim?
Kas ir grozā?

73. darba lapa

- Nosauc ģimenes locekļus!
- Noraksti vārdus un izkrāso!
- Stāsti!
Kas tas / tā ir?
Vai tas / tā ir ...?
Ko tu redzi?
Ko tu mīli?

74. darba lapa

- Aplūko un nosauc ģimenes locekļus!
- Uzraksti savu un ģimenes locekļu vārdus! Izkrāso!
- Stāsti!
Kas tas / tā ir?
Vai tas / tā ir ...?
Kāds ir tavs vārds?
Kā sauc tavu mammu / tēti / brāli / māsu?

75. darba lapa

- Uzzīmē, kas tev patīk?
- Atrodi, kas patīk pārējiem ģimenes locekļiem? Katru līniju pārvelc ar atšķirīgas krāsas zīmuli!
- Stāsti!
Man / mammai / tētīm / mā sai / brālim / patīk

76. darba lapa

- Izkrāso māmiņas portretu!
- Papildini zīmējumu pēc sava nodoma!
- Stāsti!
Kurš gadalaiks ir pašlaik?
Kad ir Mātes diena?
Ko apsveic Mātes dienā?
Kāds laiks ir zīmējumā?
Kāda ir tava māmiņa? (Mīļa, jauka, gudra, čakla, smaidīga, rūpīga)
Kā sauc tavu māmiņu?

77. darba lapa

- Uzzīmē, ko tu gribi uzdāvināt savai māmiņai!
- Izlasi apsveikumu un ieraksti savu vārdu!
- Izkrāso!
- Pa norādīto līniju izgriez un saloki!
- Stāsti!
Kad ir Mātes diena?
Ko apsveic Mātes dienā?
Kā sauc tavu māmiņu?
Kāda ir tava māmiņa?

78. darba lapa

- Apvelc ziedu kontūras!
- Ieraksti trūkstošus kārtas skaitļu ciparus!
- Skaiti ziedus!
Saki tā: pirmais, otrais utt.; pirmais zieds, otrais zieds utt.

79. darba lapa

- Nosauc un izkrāso mājdzīvniekus un mājputnu!
- Noraksti vārdus!
- Stāsti!
Kas tas / tā ir?
Vai tas / tā ir ...?
Kas dzīvo kūtī / mājā?
Kas tev patīk?

80. darba lapa

- Savelc saderīgos attēlus! Izkrāso!
- Nosauc vienu un daudzus!

81. darba lapa

- Nosauc lauku sētas iemītniekus! Izkrāso!
- Katram atrodi viņa ēnu! Savieno!
- Stāsti!
Kas tas / tā ir?
Vai tas / tā ir ...?
Kas tev patīk?

82. darba lapa

- Kurus dzīvniekus saskati?
- Izkrāso tos un nosauc!

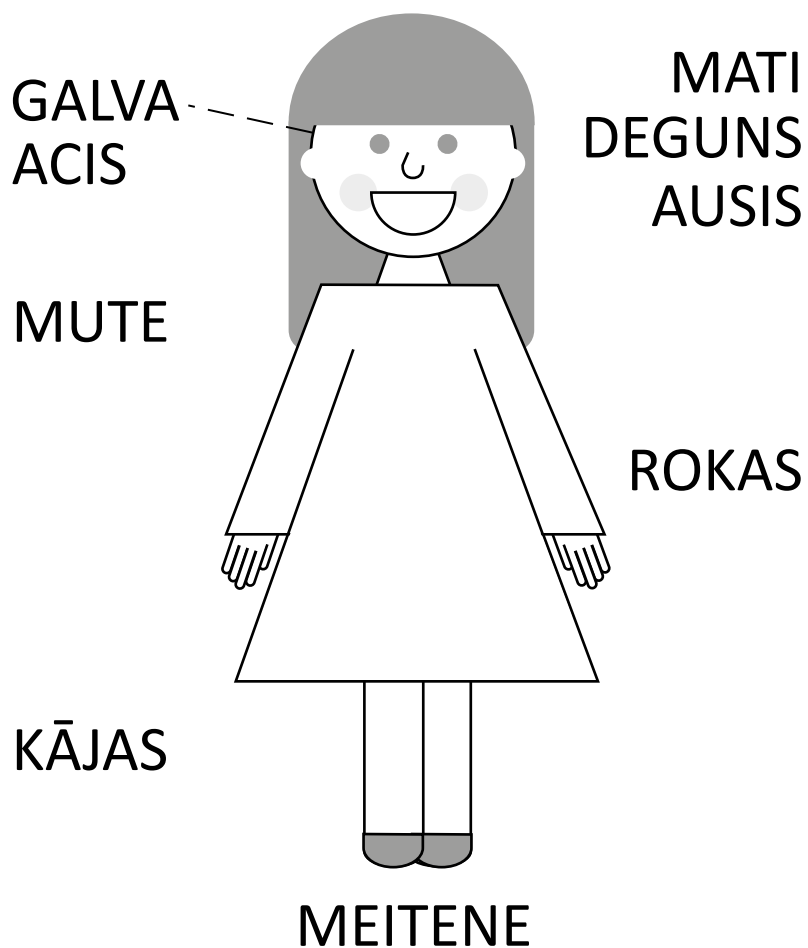
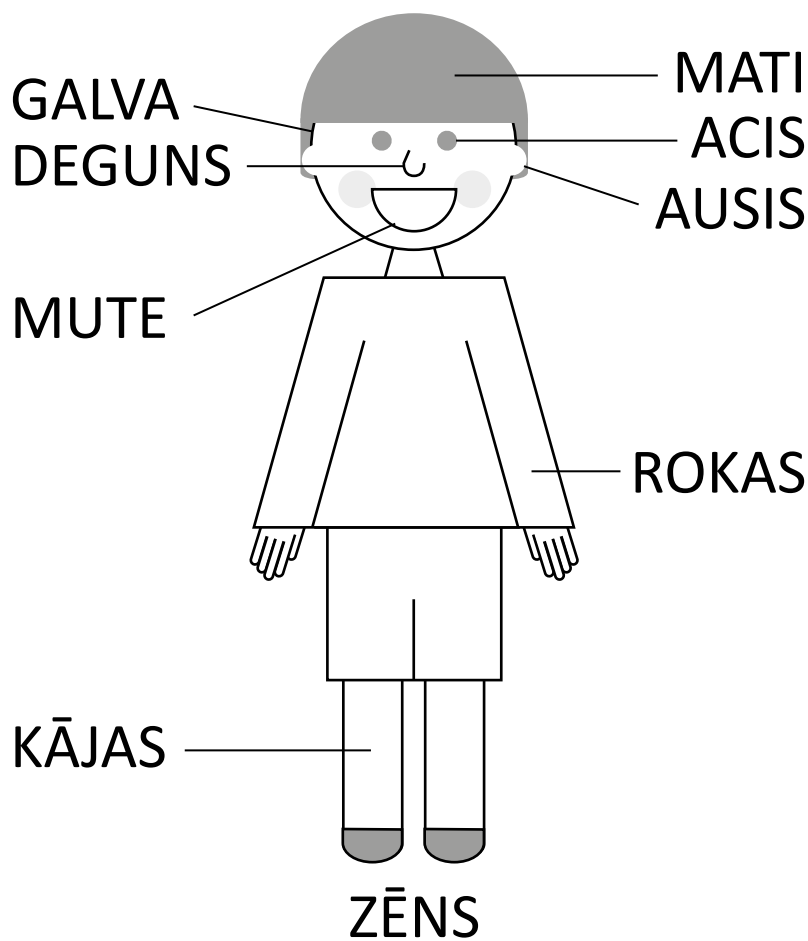



1.1. Kas es esmu? Kas tu esi?

PRIECĪGS
PRIECĪGA



SKUMJŠ
SKUMJA

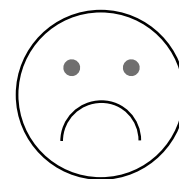

GALVA
ACIS
MUTE

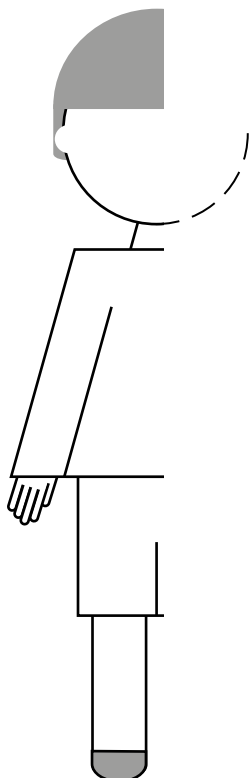

ROKAS

ZĒNS
BĒRNS
CILVĒKS
BRĀLIS

MATI
AUSIS
DEGUNS

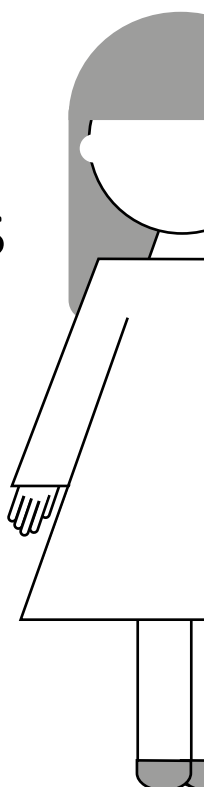

KĀJAS

MEITENE
BĒRNS
CILVĒKS
MĀSA

1. Cāļus skaita rudenī

3. darba lapa

1.1. Kas es esmu? Kas tu esi?

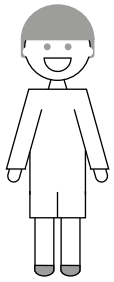

BĒRNS

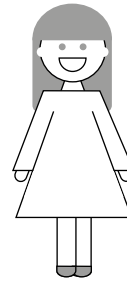
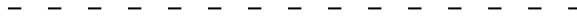

BĒRNI

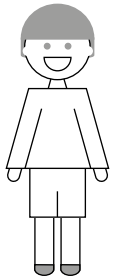
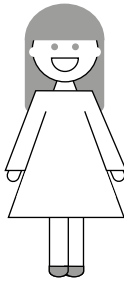
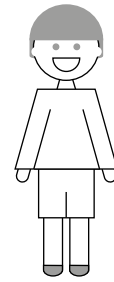

ZĒNS

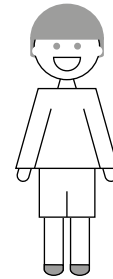

ZĒNI

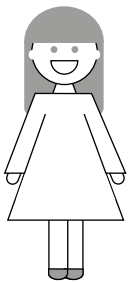
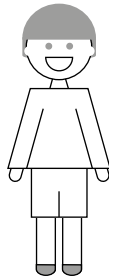
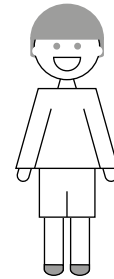

MEITENE

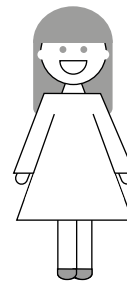
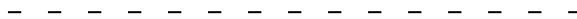

MEITENES

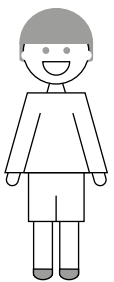
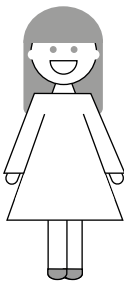
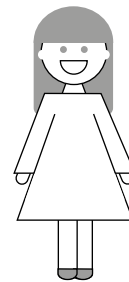

BRĀLIS

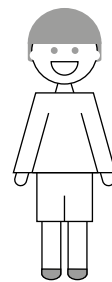
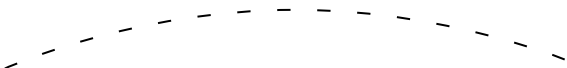

BRĀĻI

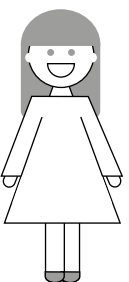
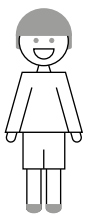
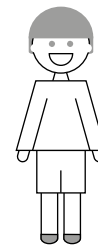

MĀSA

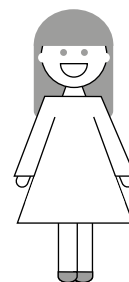
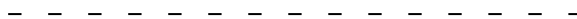

MĀSAS

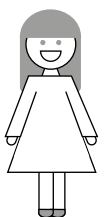
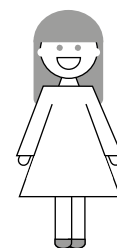



1.1. Kas es esmu? Kas tu esi?

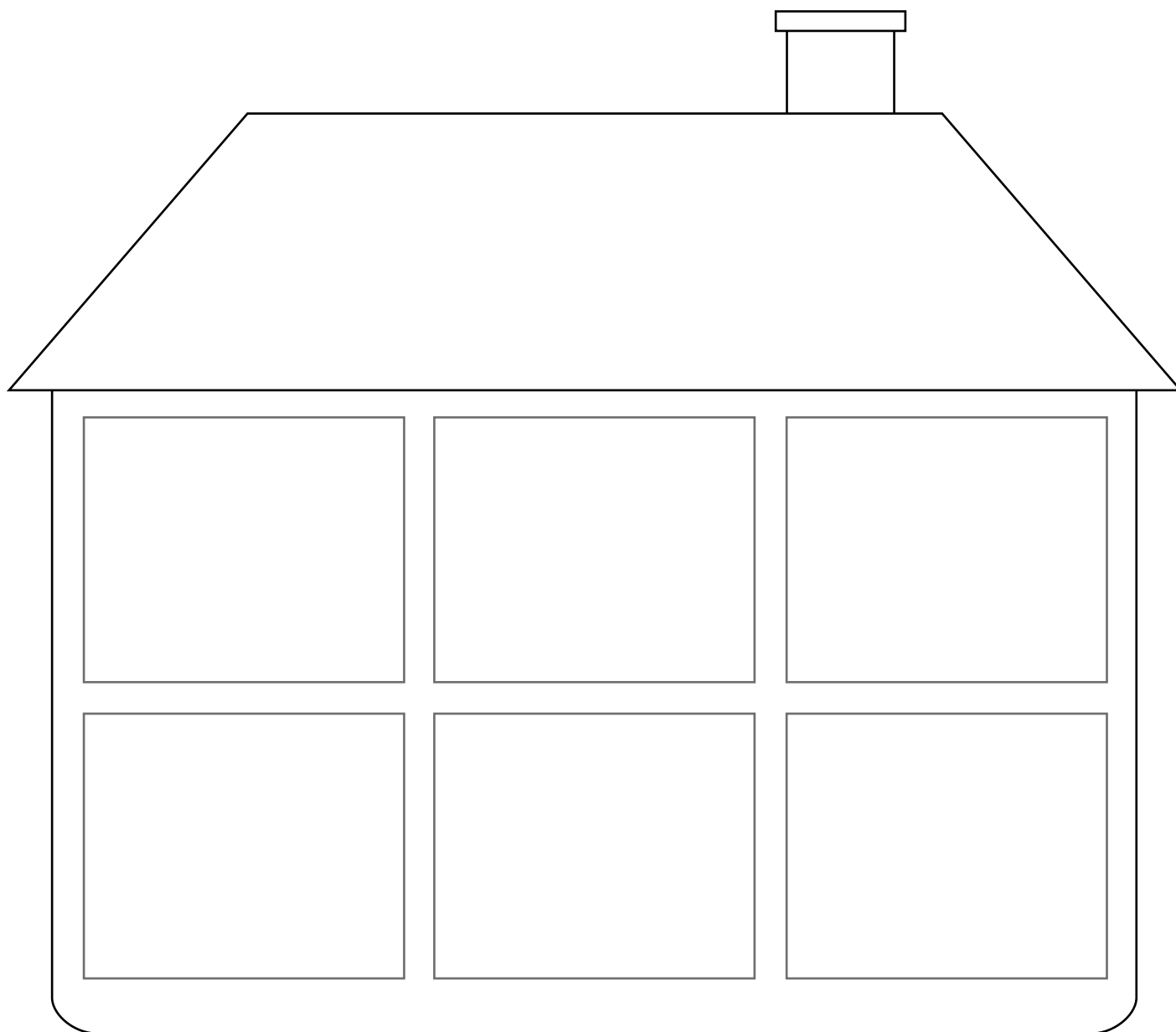

 MAMMA	 BRĀLIS	 VECMĀMIŅA
 TĒTIS	 MĀSA	 VECTĒTIŅŠ



1.1. Kas es esmu? Kas tu esi?

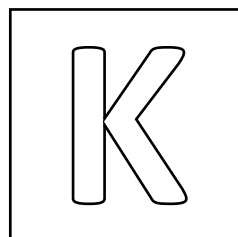
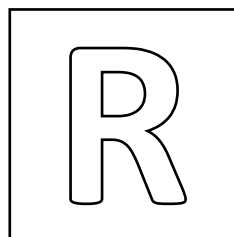
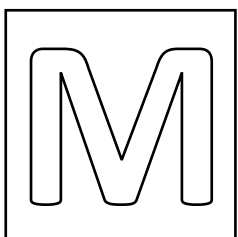
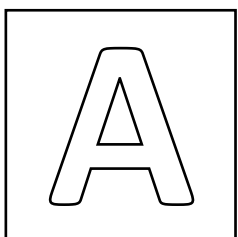
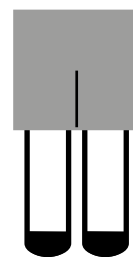
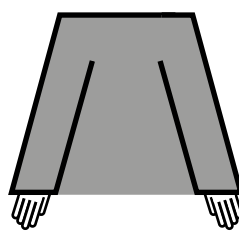
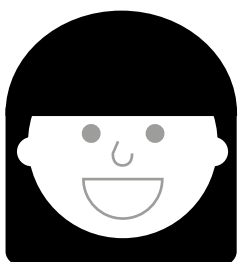
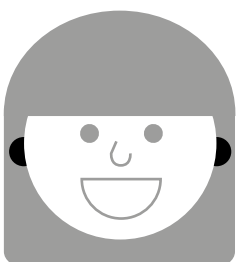
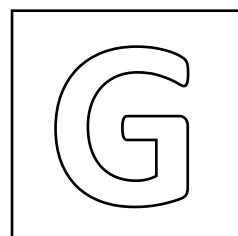
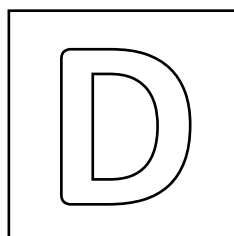
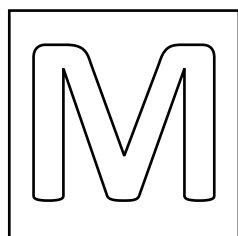
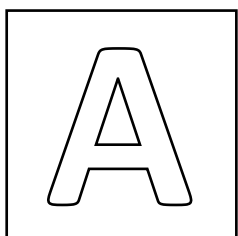
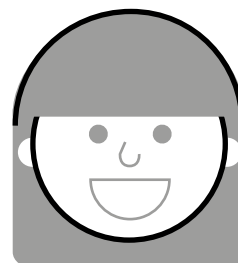
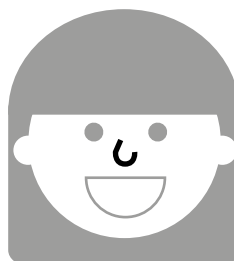
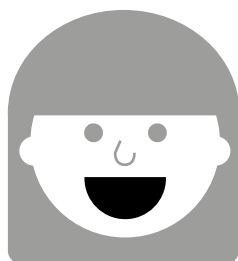
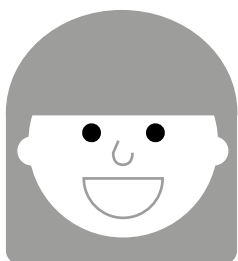

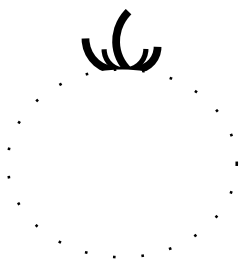

TOMĀTS

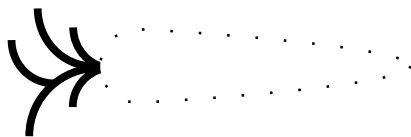

BURKĀNS

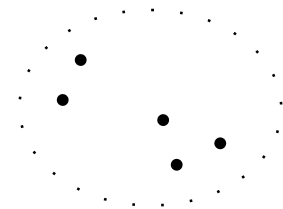

KARTUPELIS

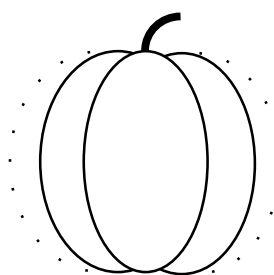

ĶIRBIS

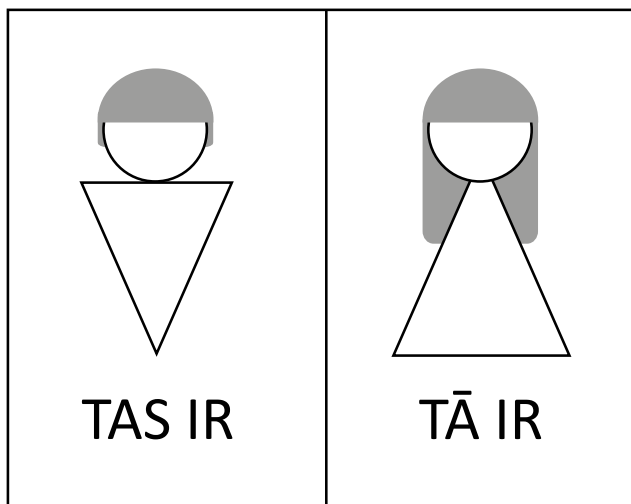

KĀPOSTS

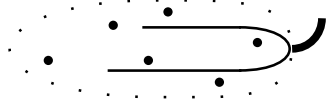

GURĶIS

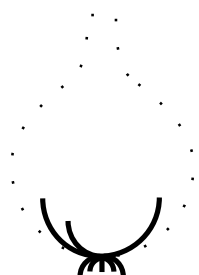

SĪPOLS

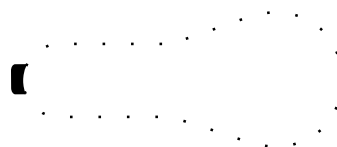

KABACIS

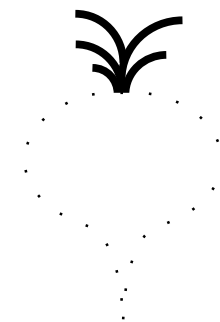

BIETE

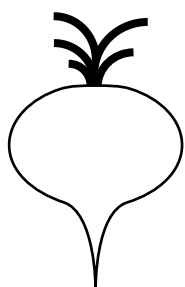

BIETE

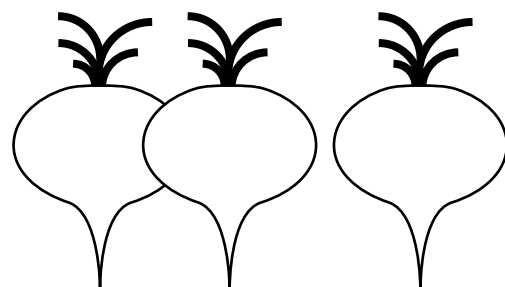
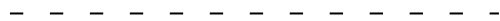

BIETES

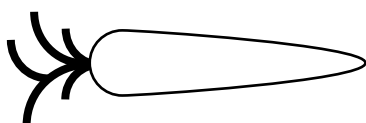

BURKĀNS

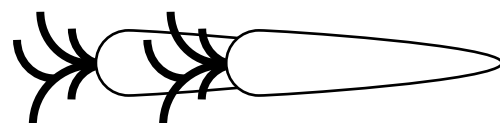

BURKĀNI



KĀPOSTS



KĀPOSTI

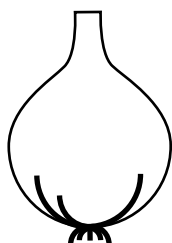

SĪPOLS

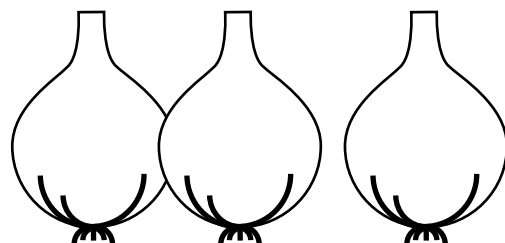
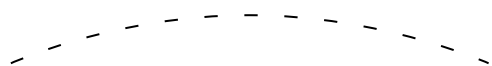

SĪPOLI

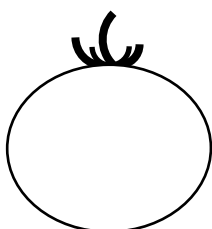

TOMĀTS

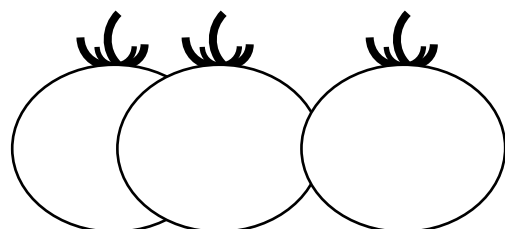

TOMĀTI

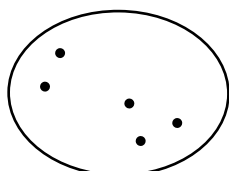

KARTUPELIS

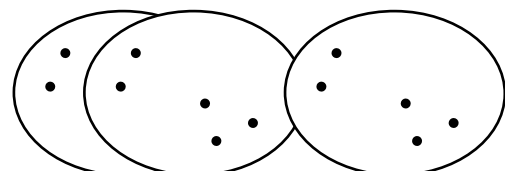

KARTUPEĻI

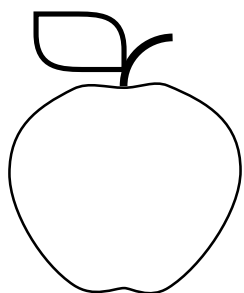

ĀBOLS

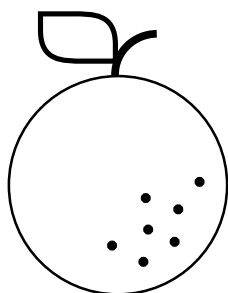

APELSĪNS

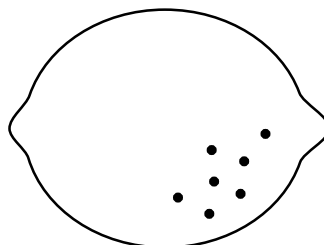

CITRONS

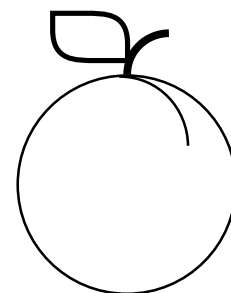

PERSIKS

 MAN GARŠO	 MAN NEGARŠO
---	--

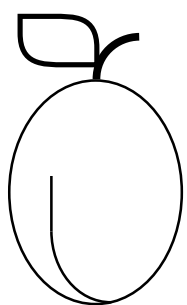

PLŪME

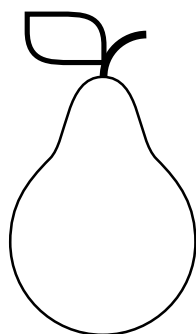

BUMBIERIS

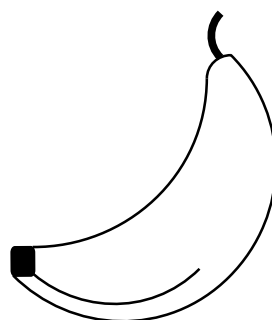



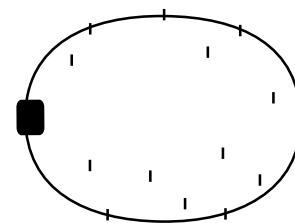

BANĀNS

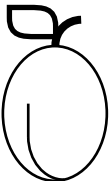
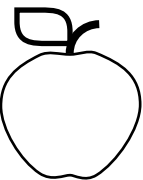

KIVI

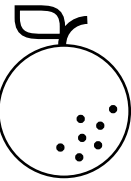
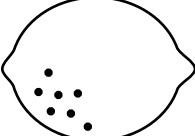

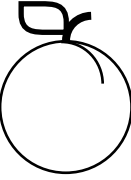
PLŪME

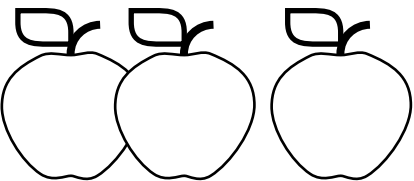
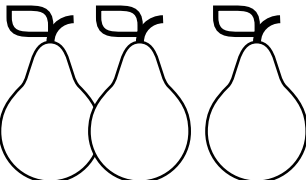
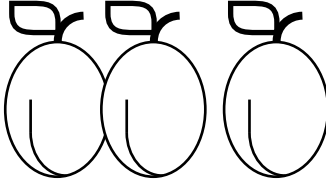
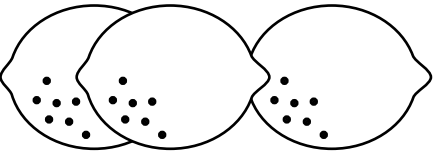
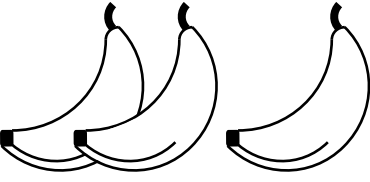
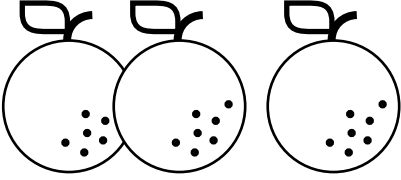
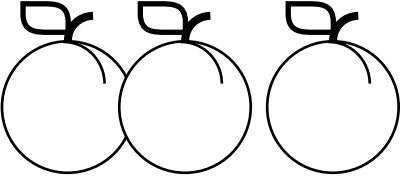
ĀBOLS

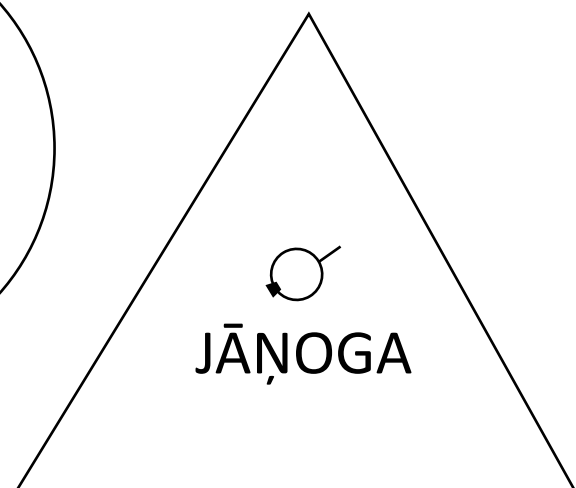
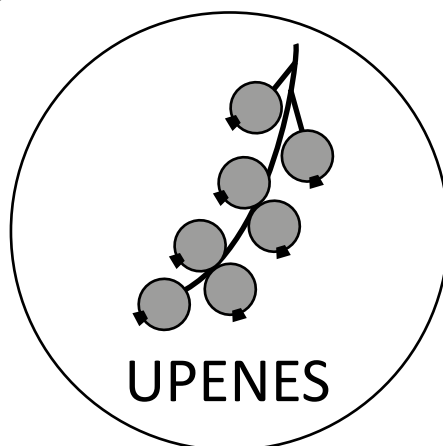
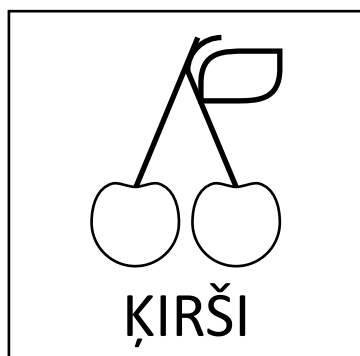
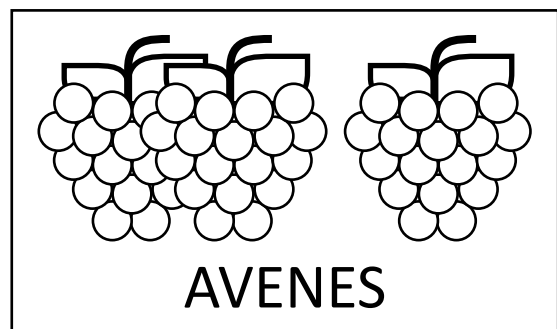
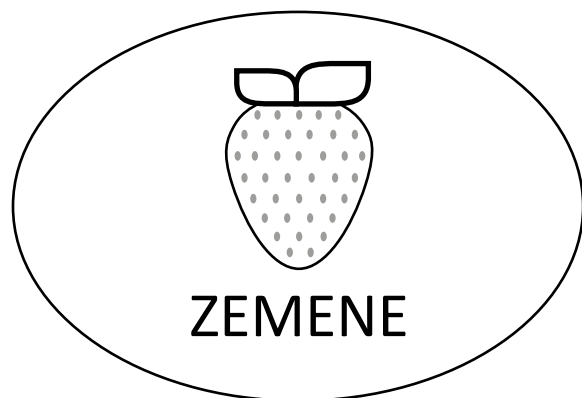
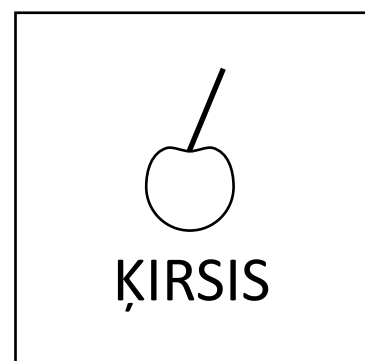
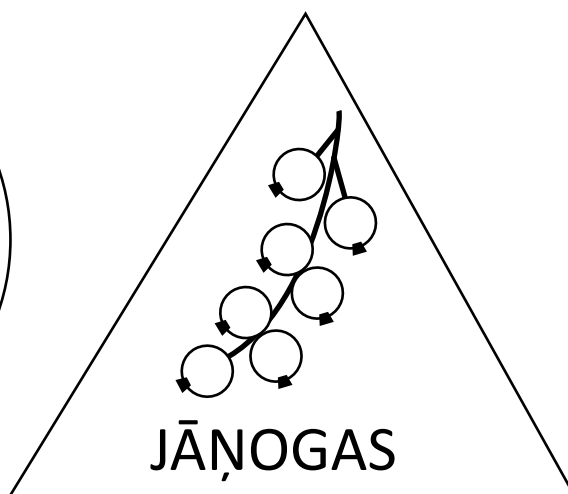
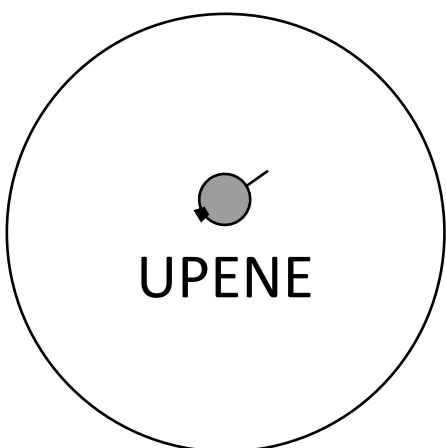
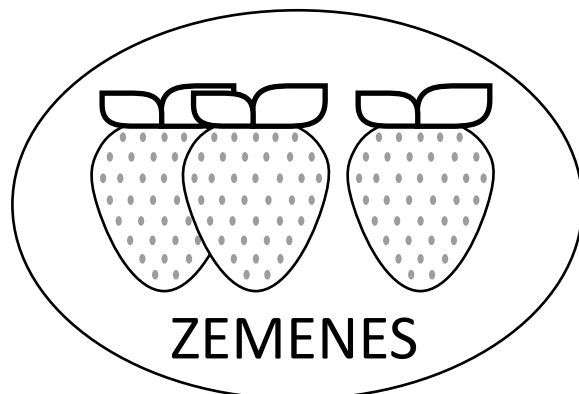
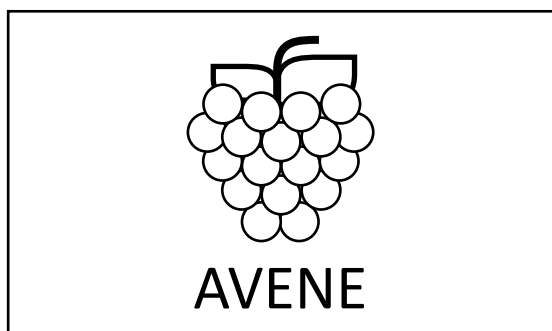
BUMBIERIS

APELSĪNS

CITRONS

BANĀNS

PERSIKS



ĀBOLI

BUMBIERI

PLŪMES

CITRONI

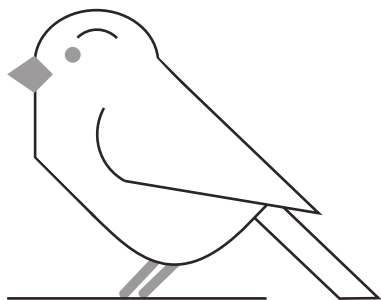
BANĀNI

APELSĪNI

PERSIKI



2. Kas notiek rudenī?

11. darba lapa

2.1. Uz siltajām zemēm!



ZVIRBULIS

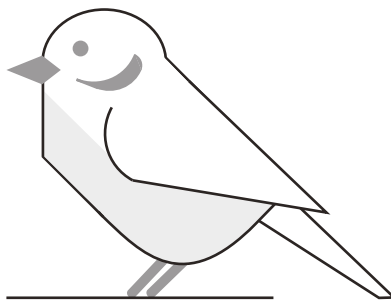

ZĪLĪTE

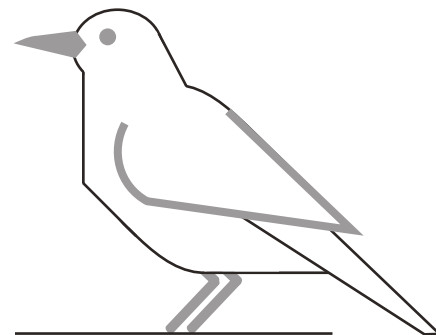

VĀRNA

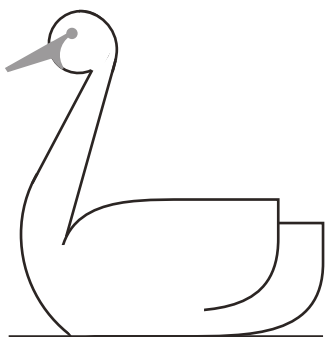
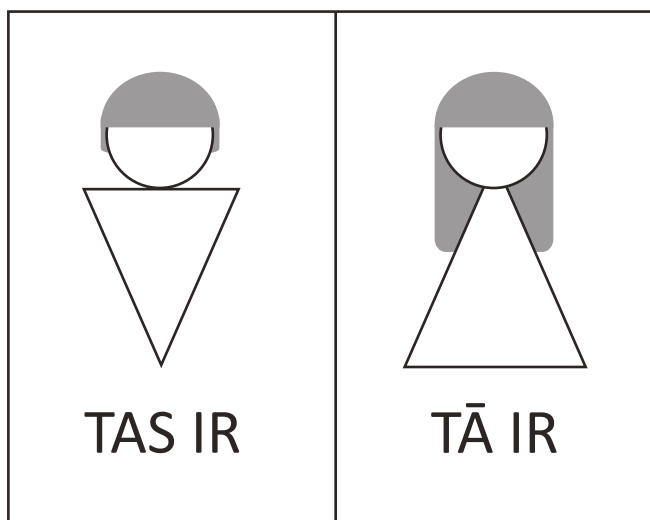

GULBIS

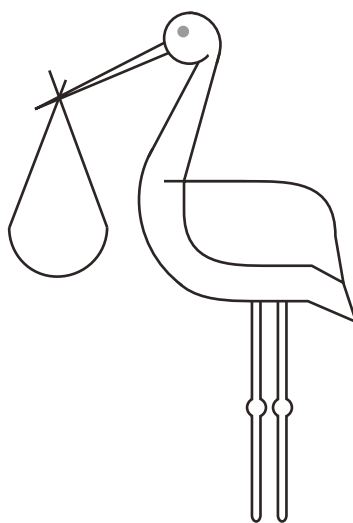

STĀRĶIS

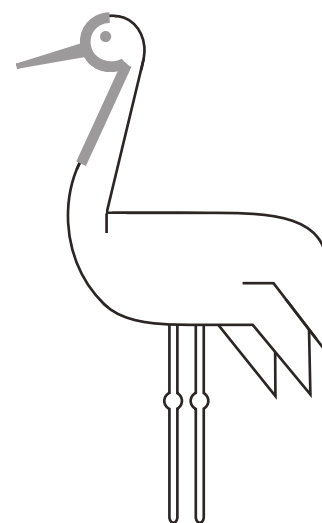

DZĒRVE

2. Kas notiek rudenī?
2.1. Uz siltajām zemēm!

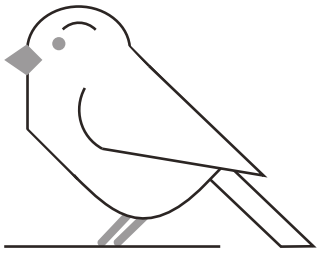
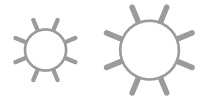

ZVIRBULIS

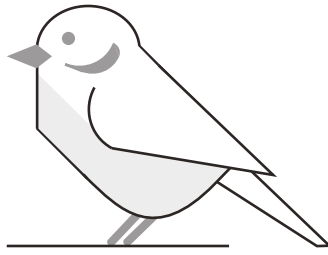

ZĪLĪTE

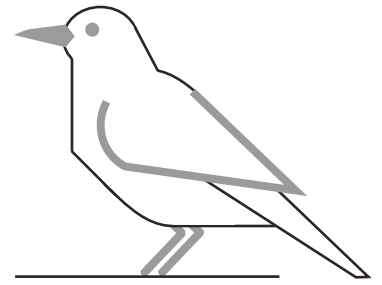

VĀRNA

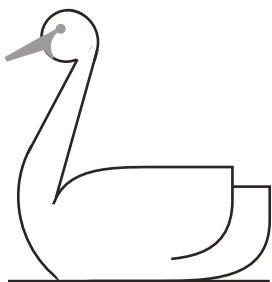
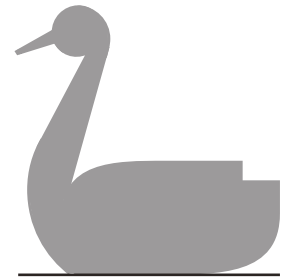
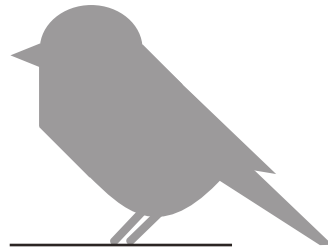
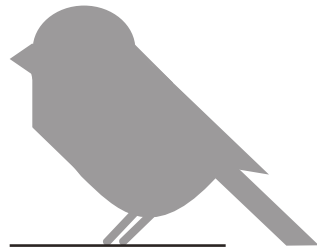
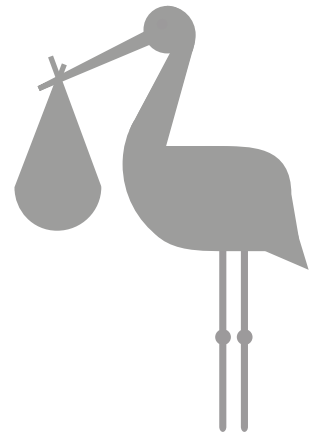
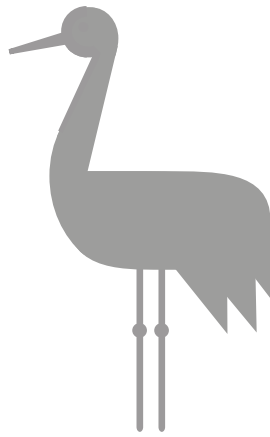
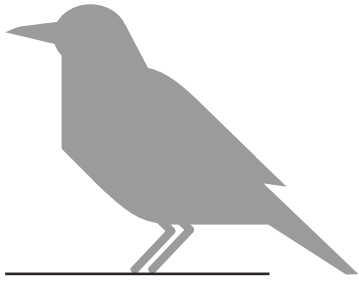

GULBIS

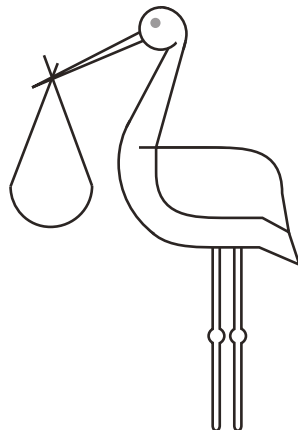

STĀRĶIS

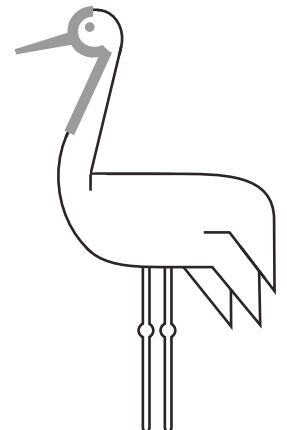

DZĒRVE

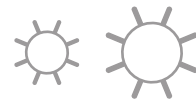

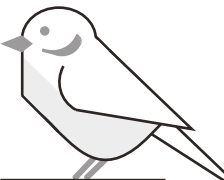
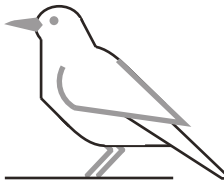
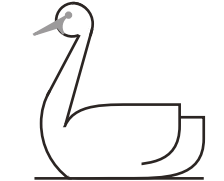
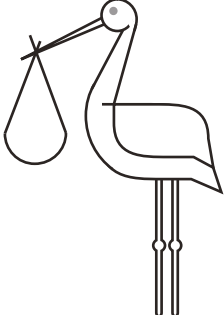
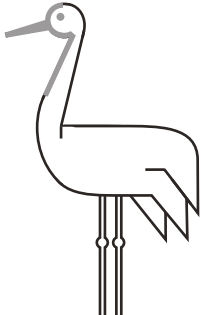

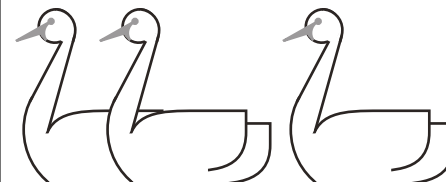
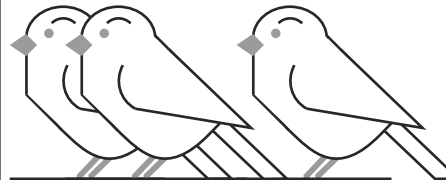
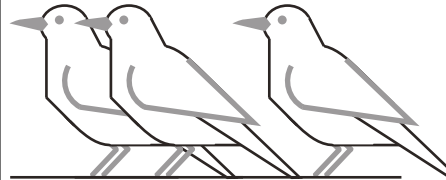
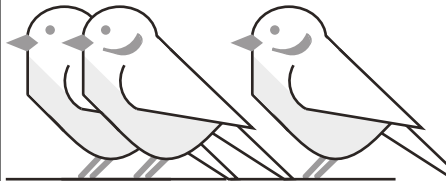
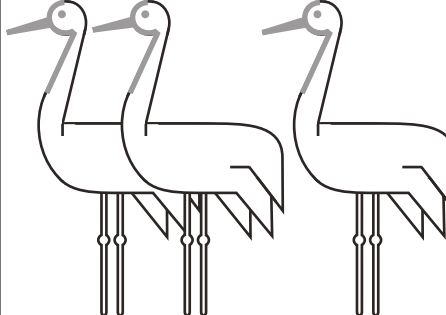
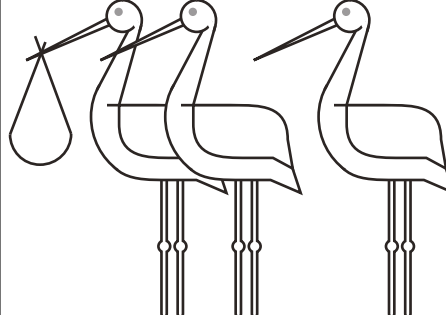
ZVIRBULIS

ZĪLĪTE

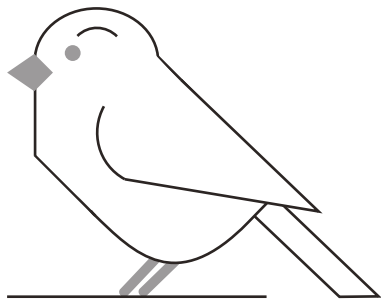
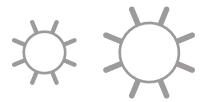
VĀRNA

GULBIS

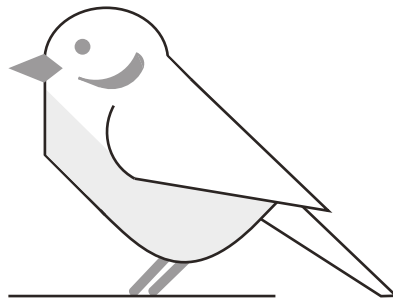
STĀRĶIS

DZĒRVE

GULBJI

ZVIRBUĻI

VĀRNAS

ZĪLĪTES

DZĒRVES

STĀRĶI

2. Kas notiek rudenī?
2.1. Uz siltajām zemēm!



ZVIRBULIS



ZĪLĪTE

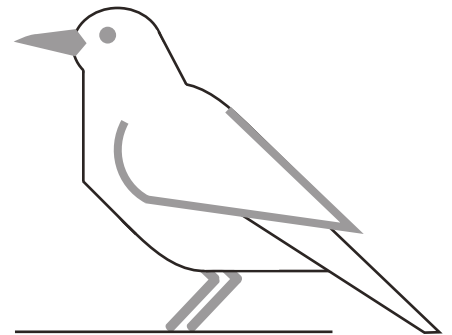

VĀRNA

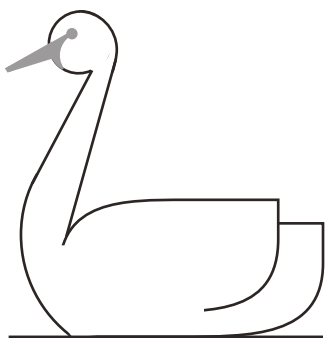
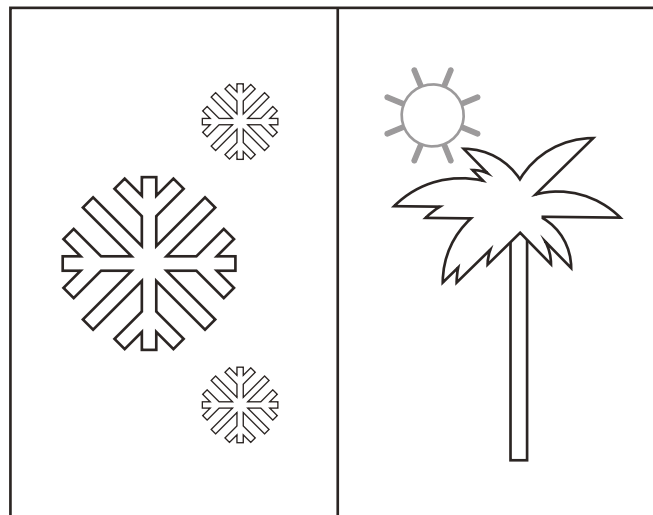

GULBIS

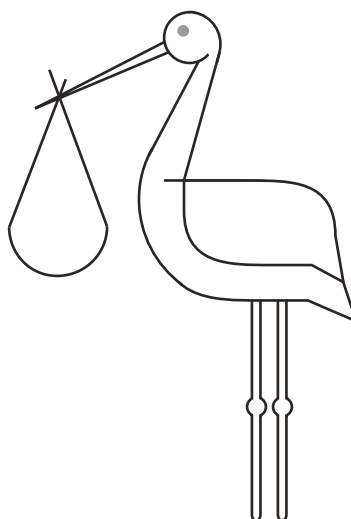

STĀRĶIS

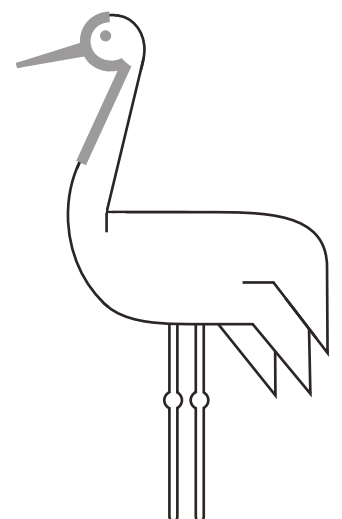

DZĒRVE

2. Kas notiek rudenī?
2.1. Uz siltajām zemēm!

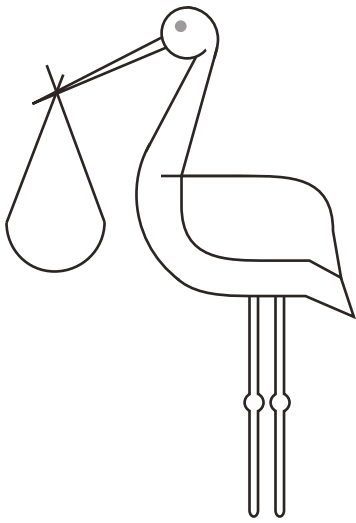
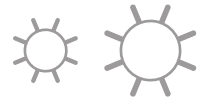

STĀRĶIS

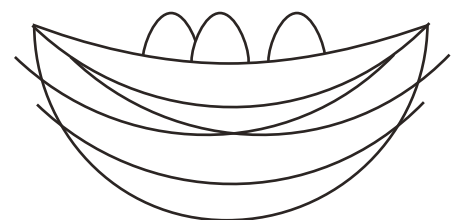
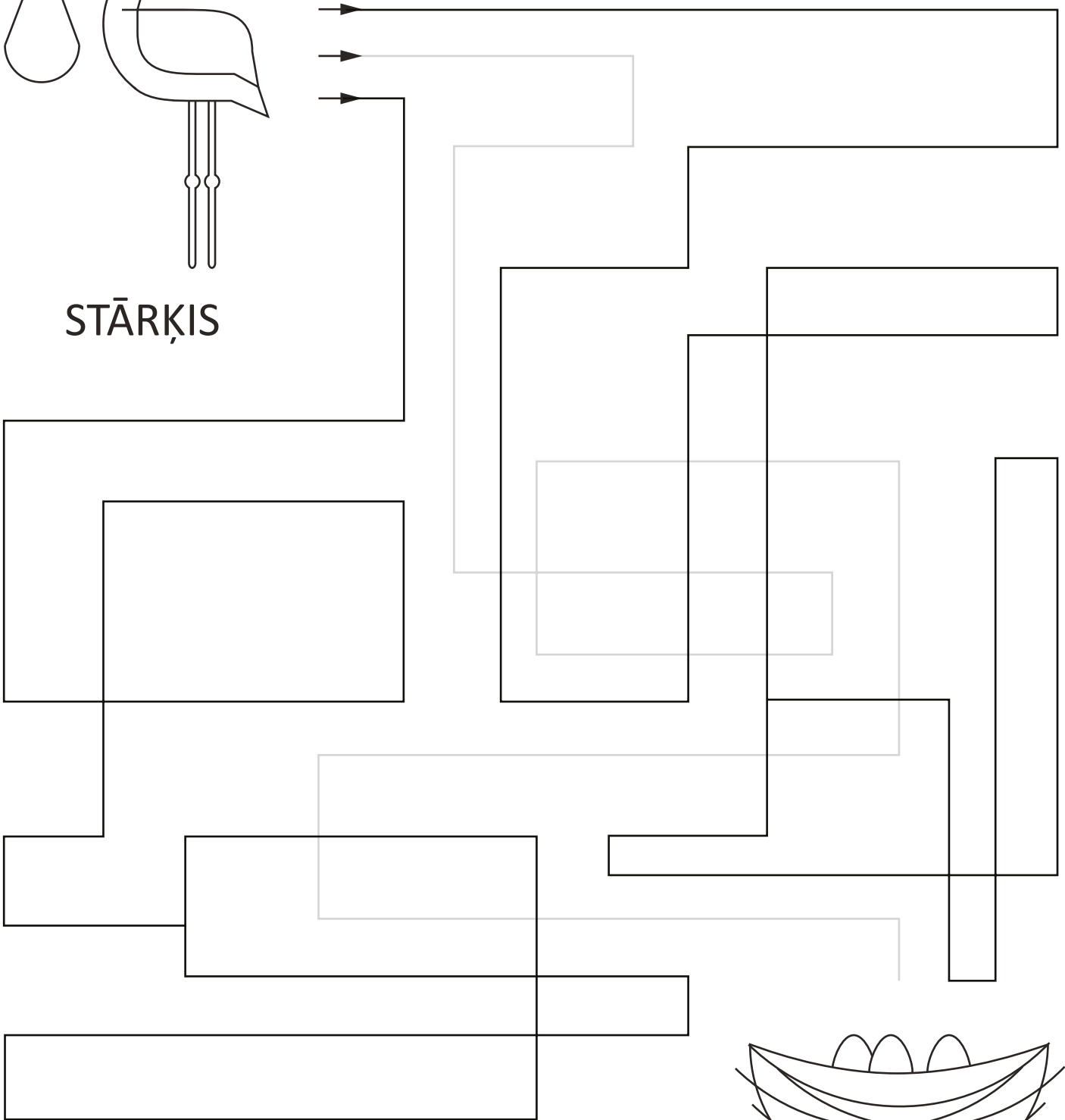

LIGZDA

2. Kas notiek rudenī?
2.2. Krāsains rudens

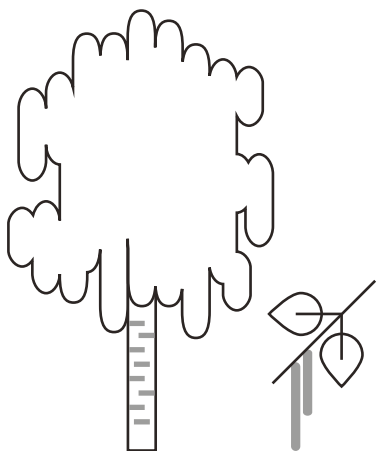

BĒRZS

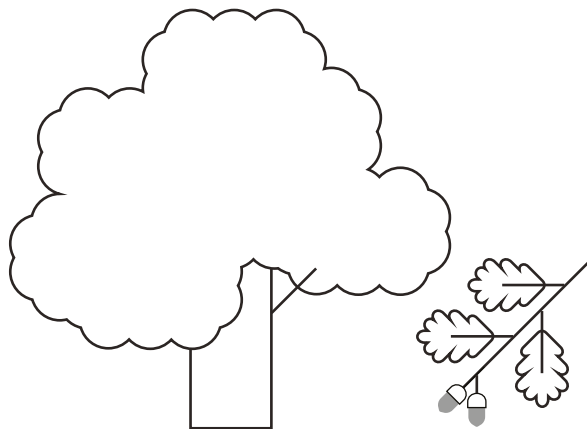

OZOLS

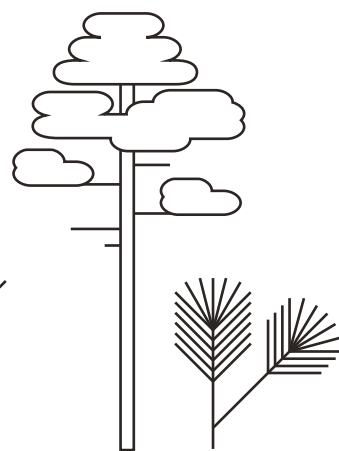

PRIEDE

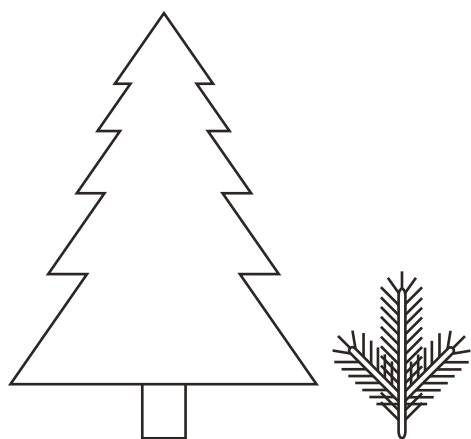
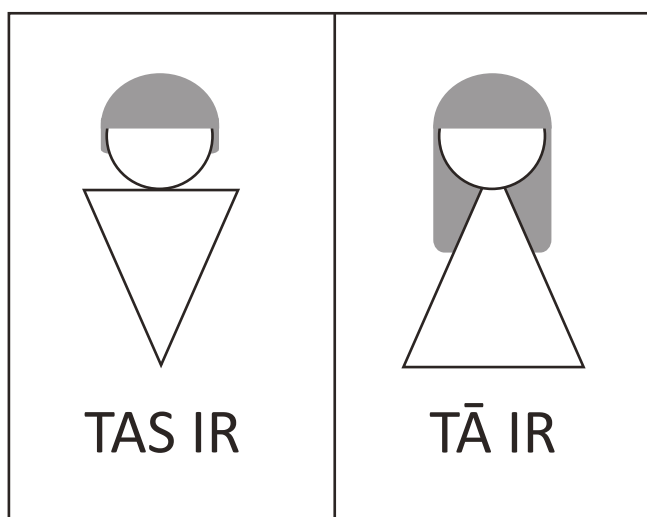

EGLE

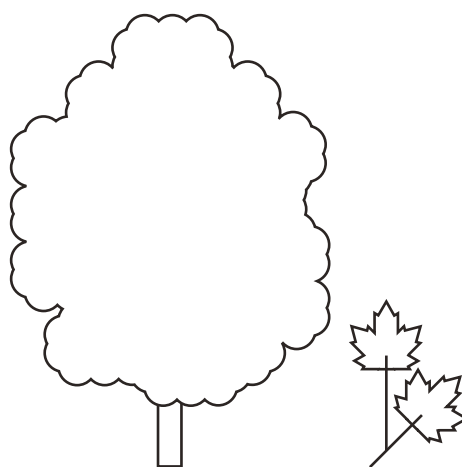

KĻAVA

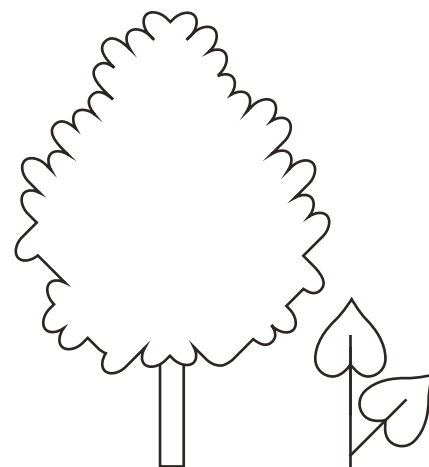

LIEPA

2. Kas notiek rudenī?
2.2. Krāsains rudens

17. darba lapa

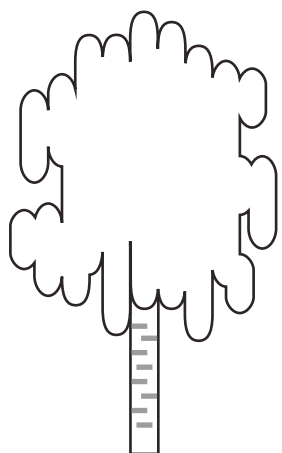

BĒRZS

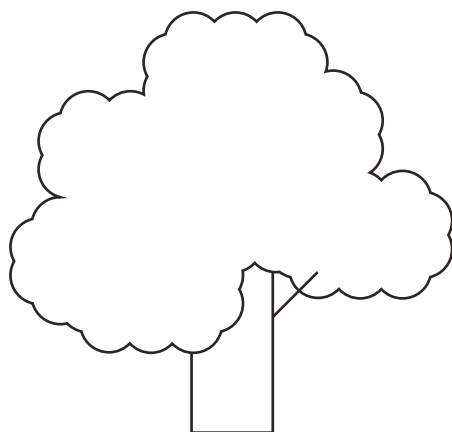

OZOLS

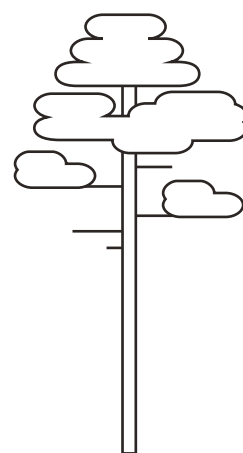

PRIEDE

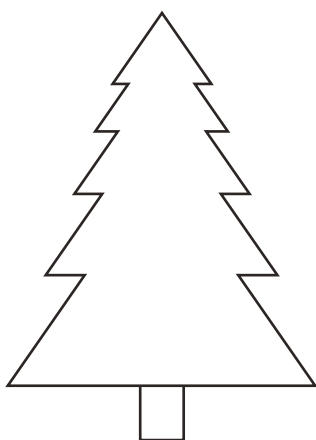
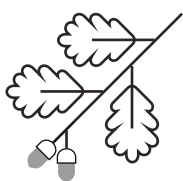

EGLE

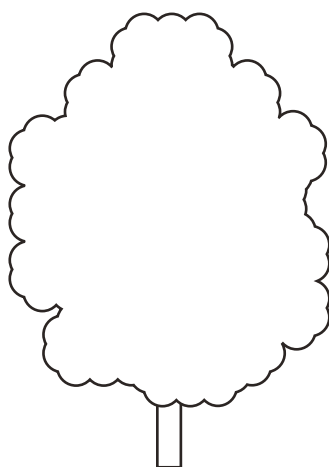

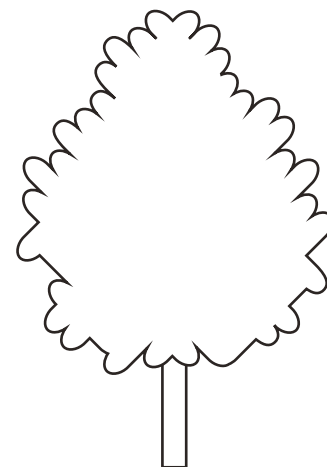

KĻAVA



LIEPA

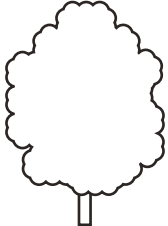
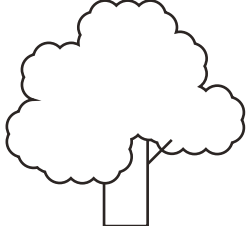
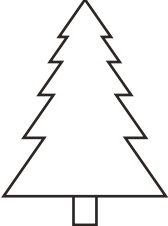
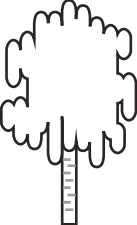

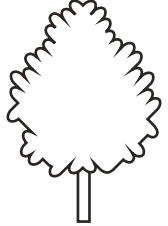

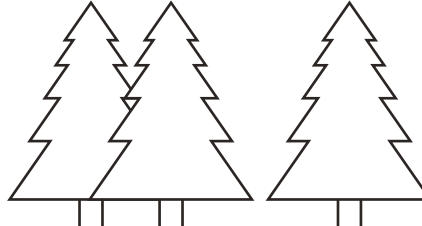
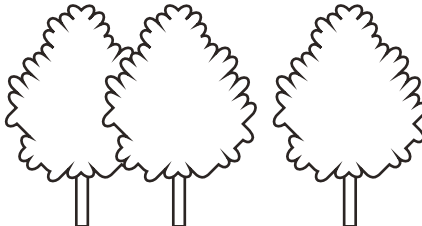
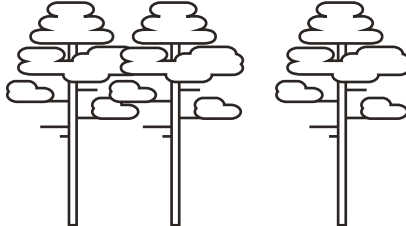
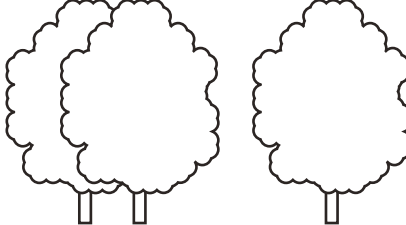
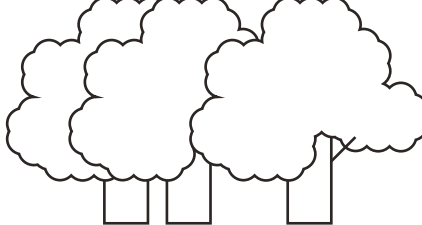
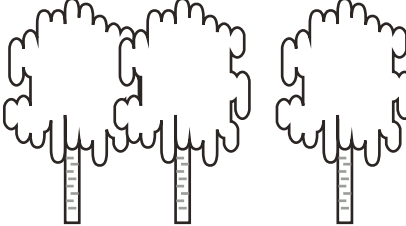
KĻAVA

OZOLS

EGLE

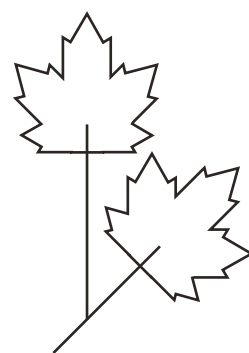
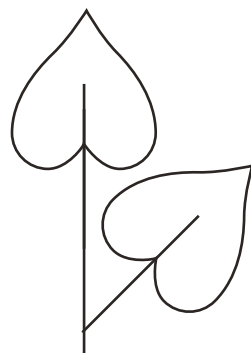
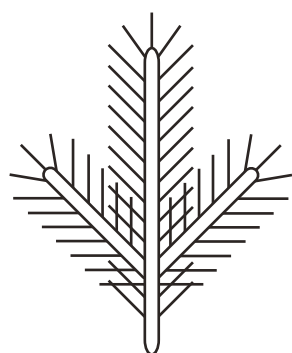
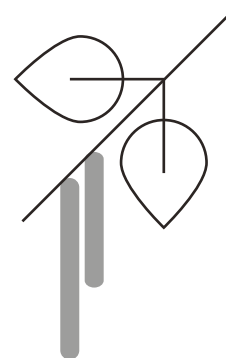
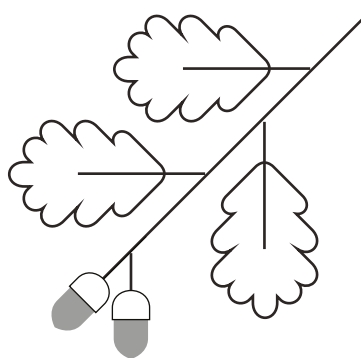
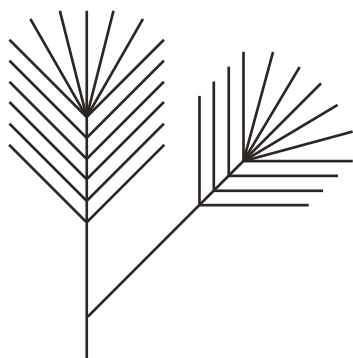
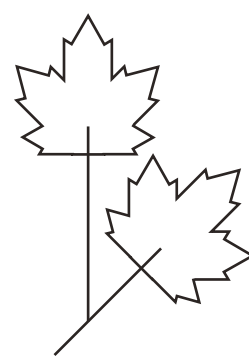
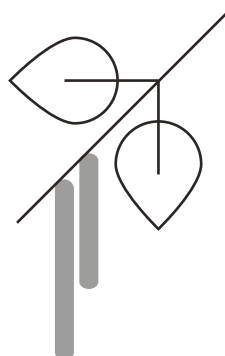
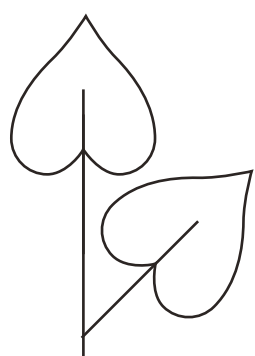
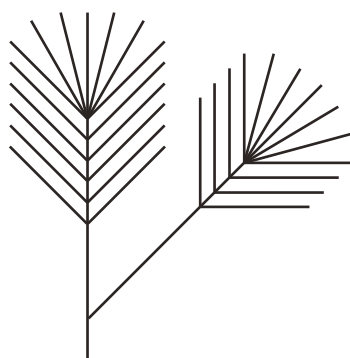
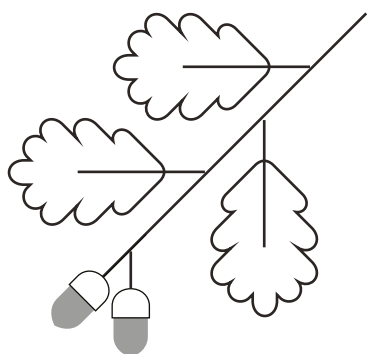
BĒRZS

PRIEDE

LIEPA



EGLES

LIEPAS

PRIEDES

KĻAVAS

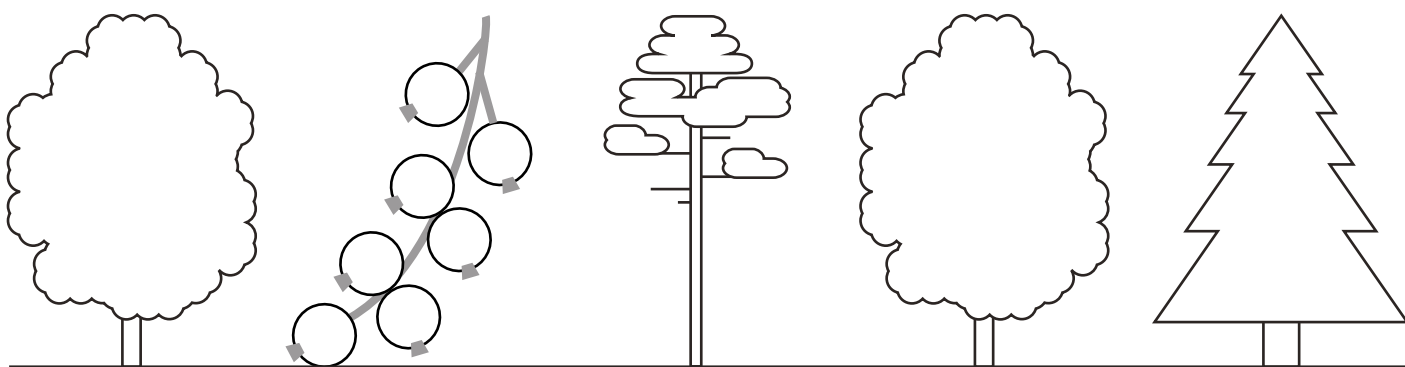
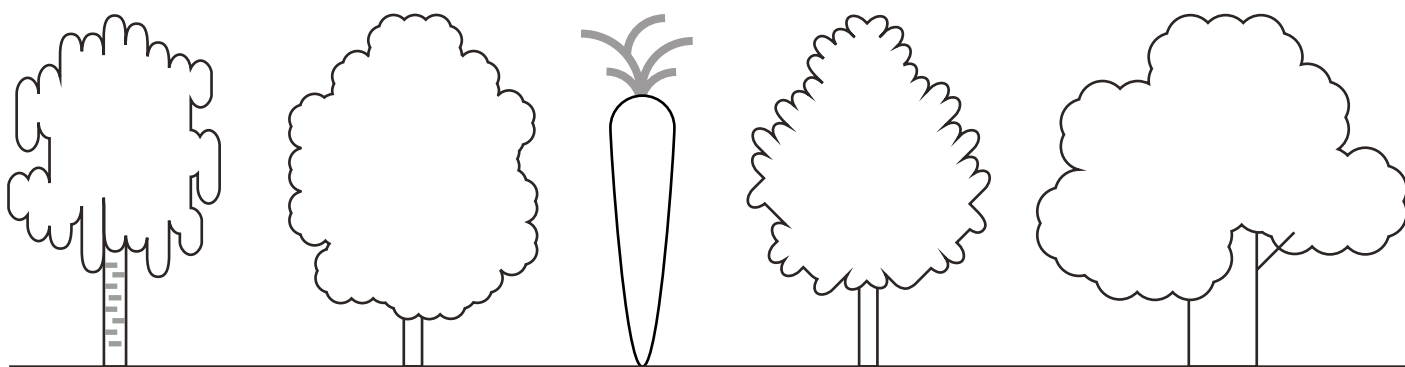
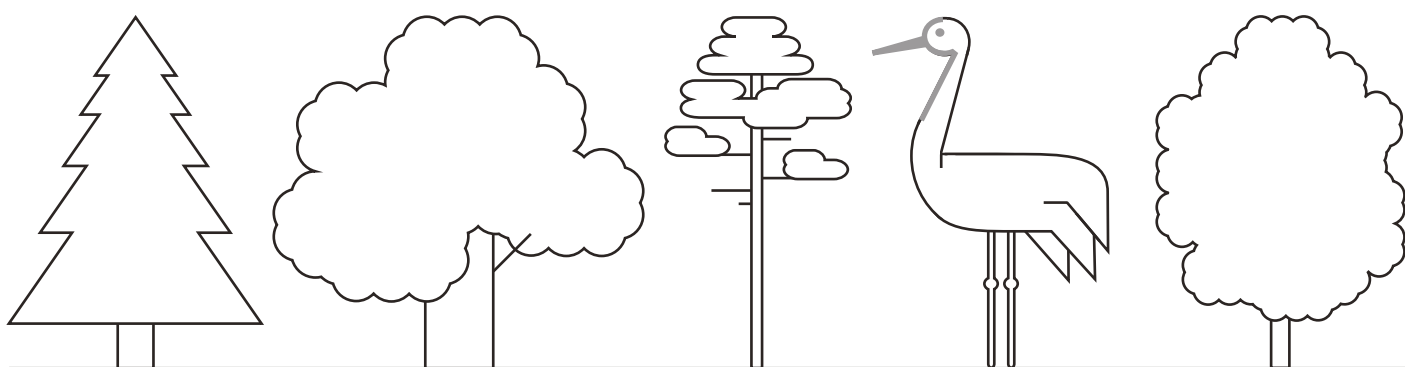
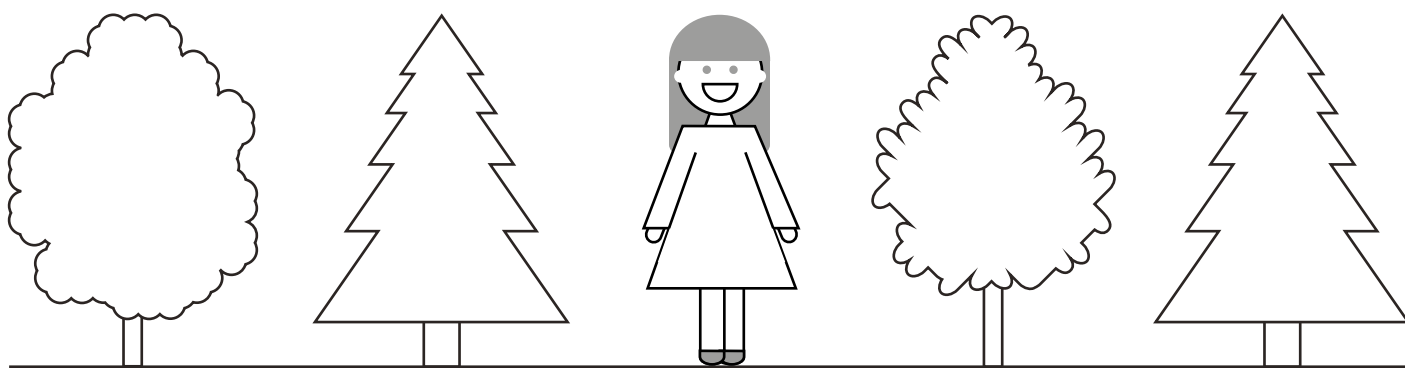
OZOLI

BĒRZI

2. Kas notiek rudenī?
2.2. Krāsains rudens

19. darba lapa



2. Kas notiek rudenī?
2.2. Krāsains rudens



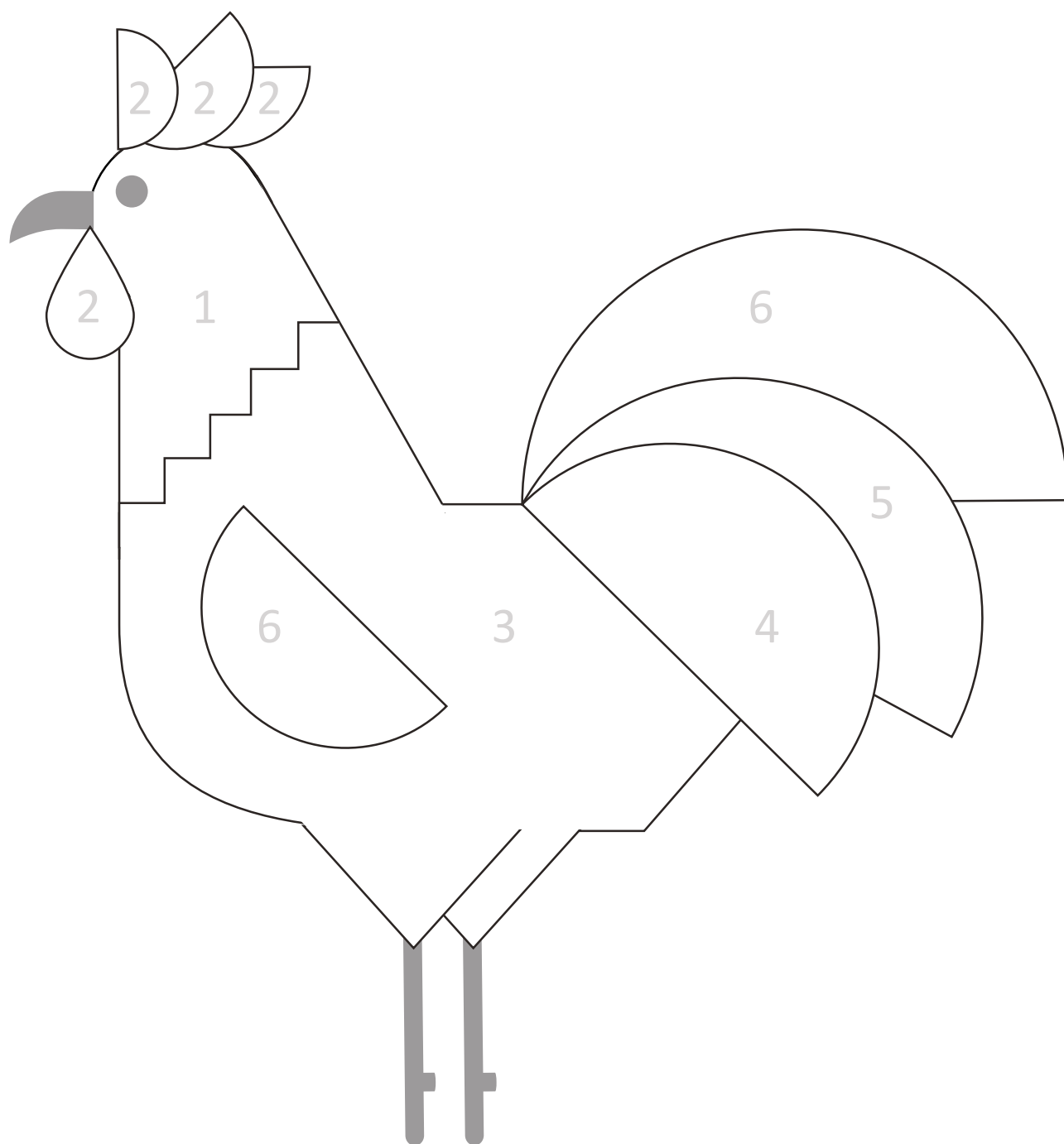

1- dzeltens
2- sarkans

3- brūns
4- violets

5- zaļš
6- zils

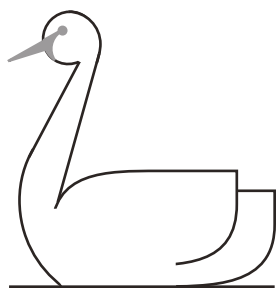

VIENS

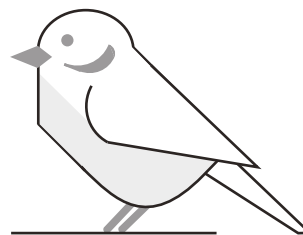

VIENA

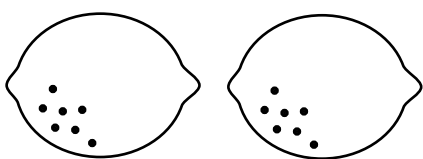

DIVI

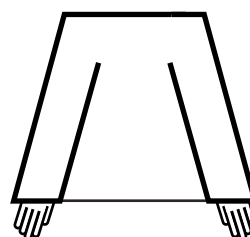

DIVAS

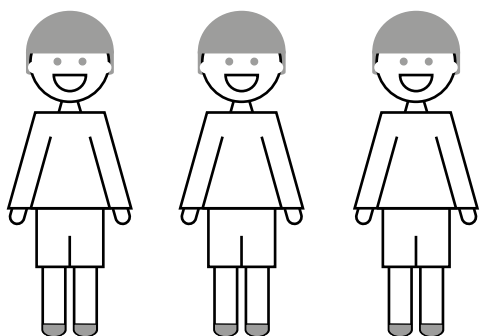

TRĪS

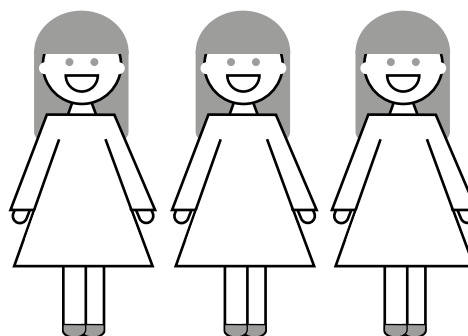

TRĪS

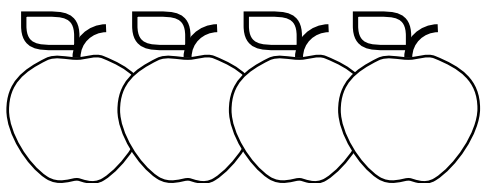

ČETRI

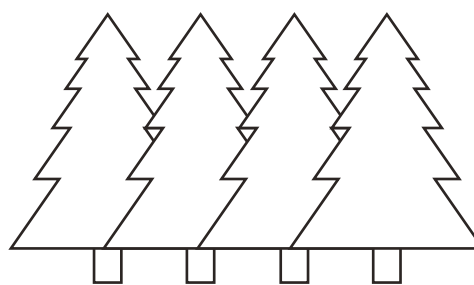

ČETRAS

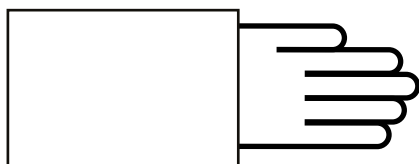

PIECI

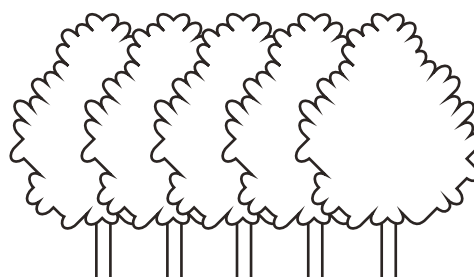

PIECAS



3.1. Mārtiņi klāt!

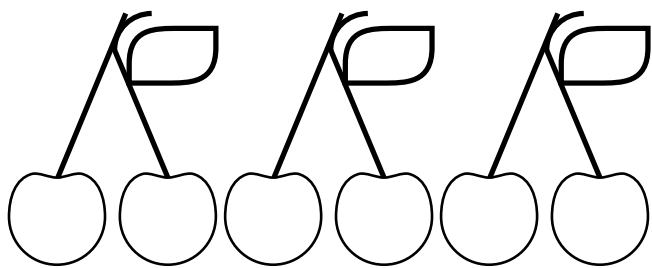

SEŠI

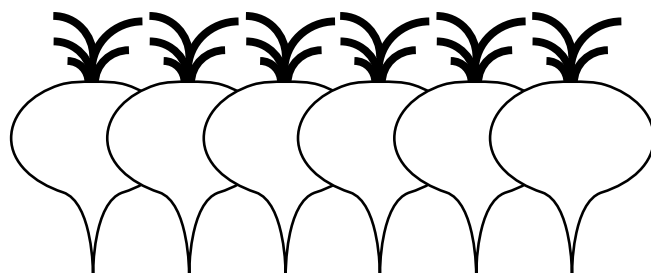

SEŠAS

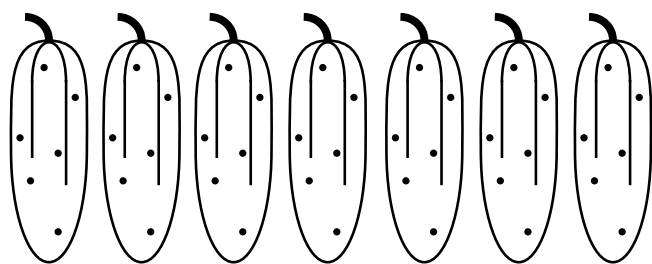

SEPTIŅI

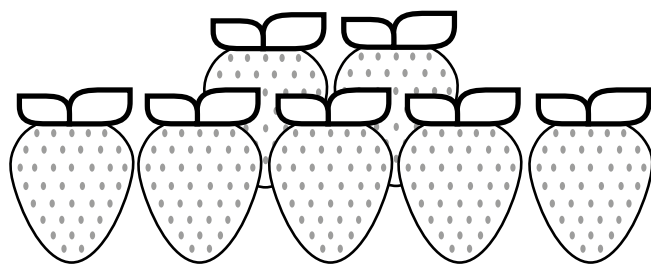

SEPTIŅAS



ASTOŅI

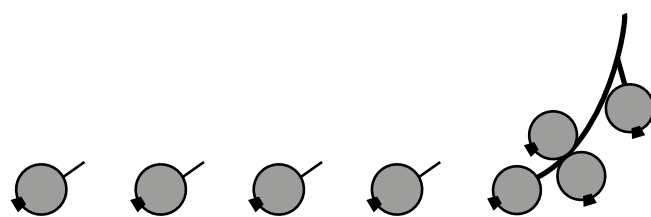

ASTOŅAS

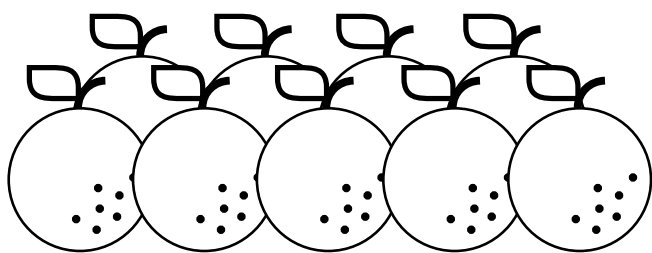

DEVIŅI

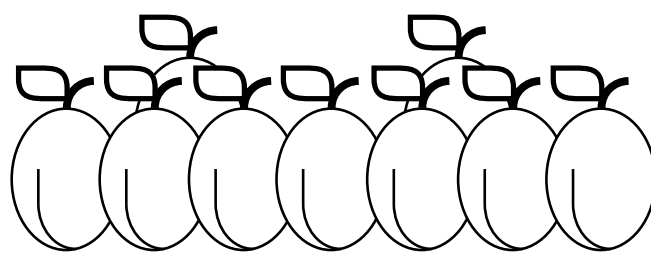

DEVIŅAS

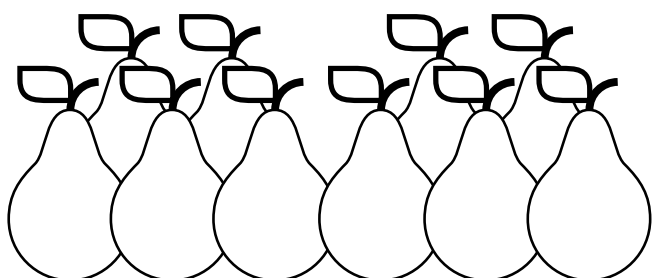

DESMIT

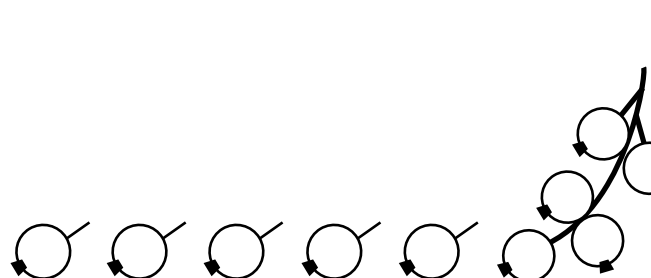

DESMIT

3. Cik daudz svētku!

3.1. Mārtiņi klāt!

24. darba lapa

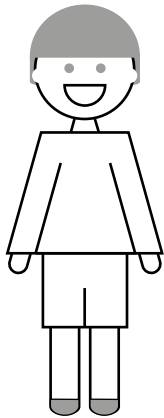

1

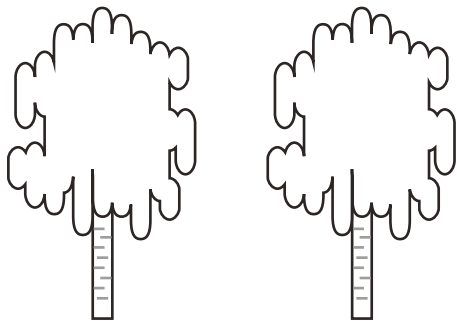
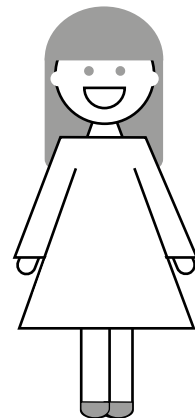

2

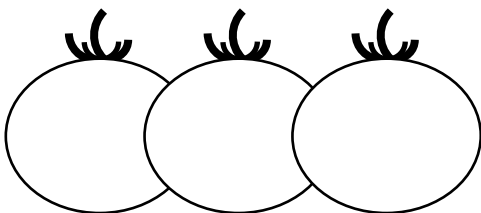
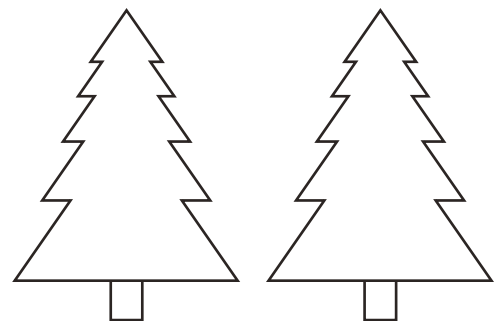

3

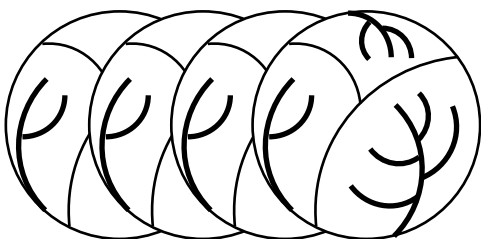
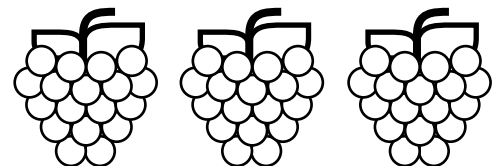

4

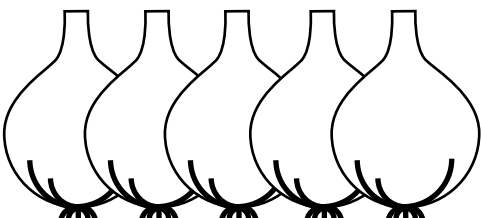
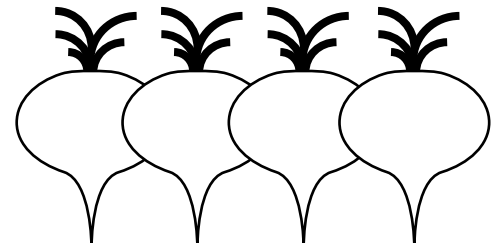

5

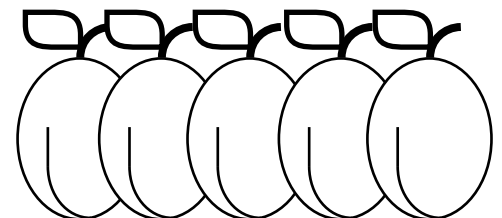

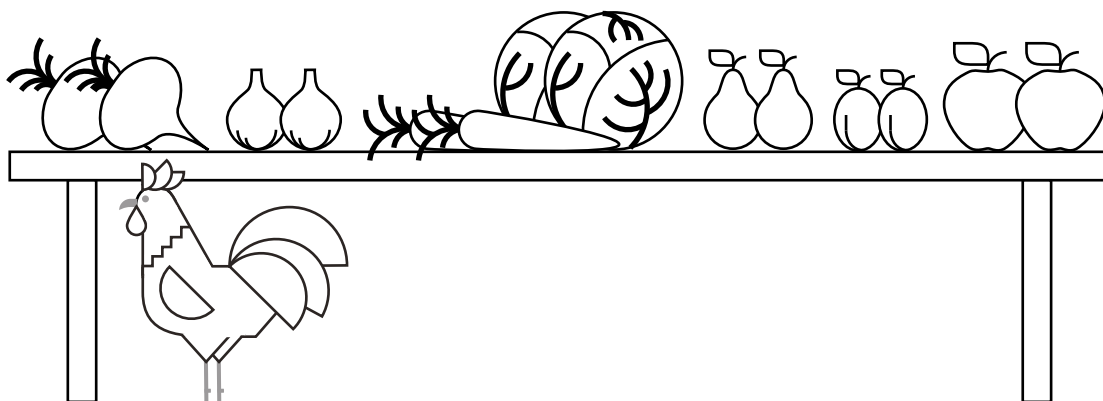
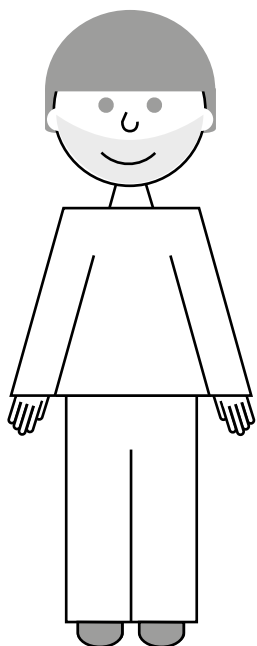

TĒTIS

ES PĀRDODU...

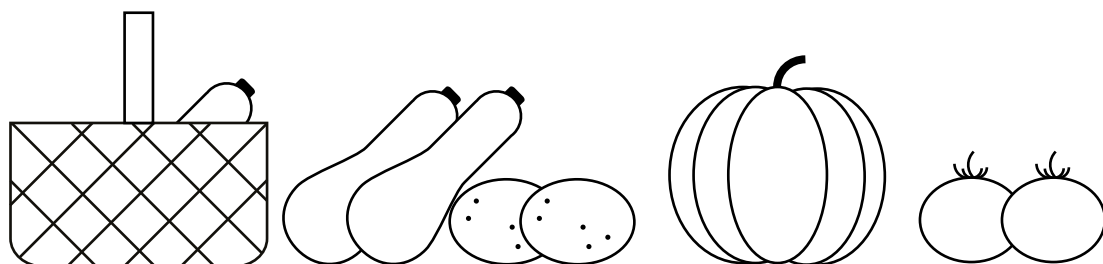
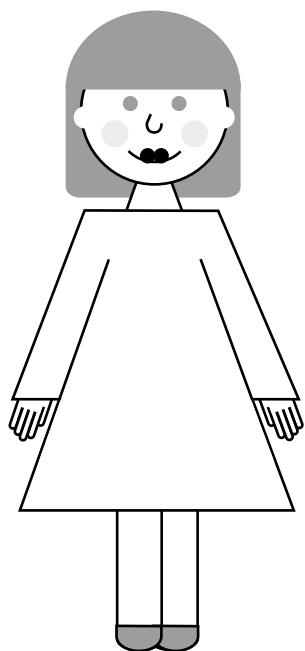

MAMMA

ES PĒRKU...

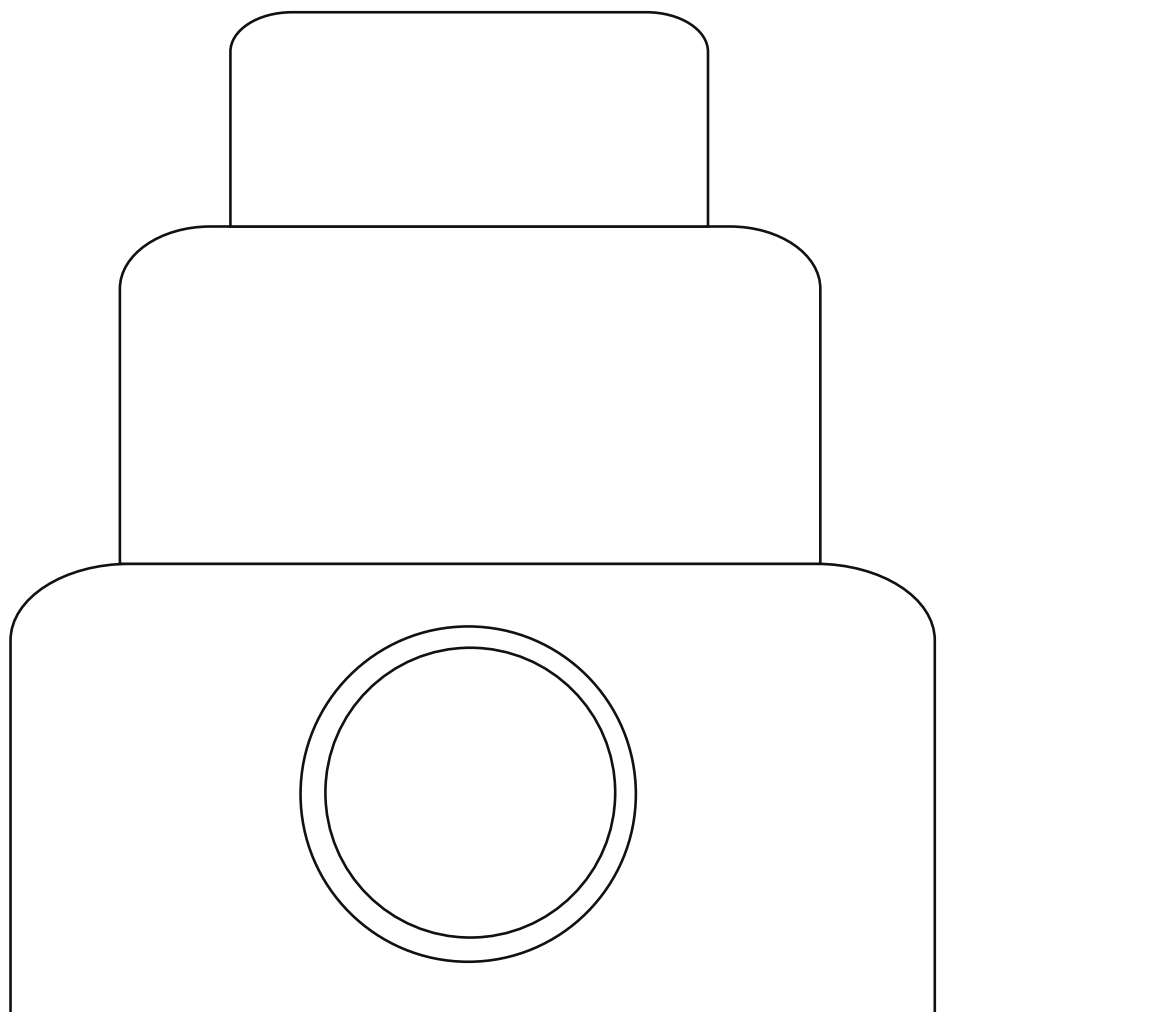
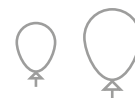

TORTE

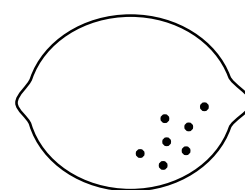
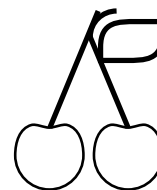
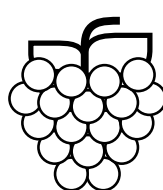
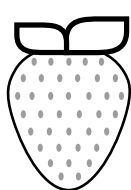
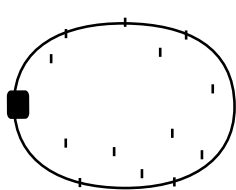
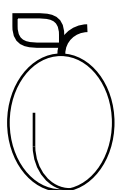
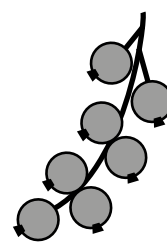
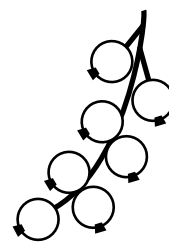
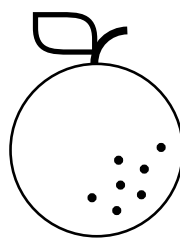
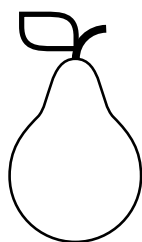
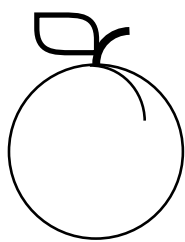
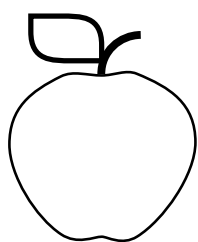

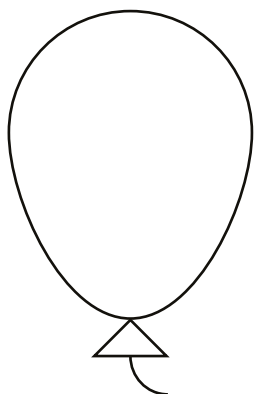
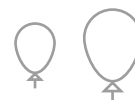

BALONS

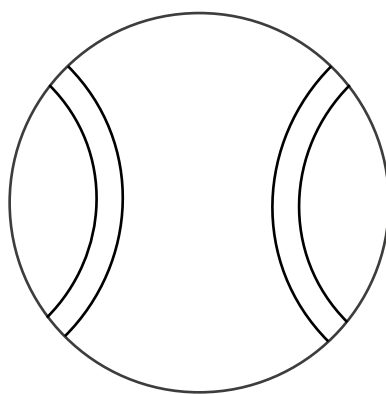

BUMBA

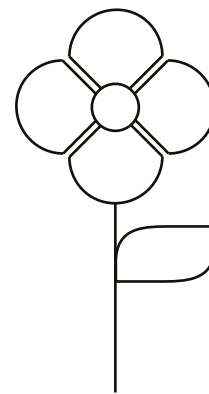

PUĶE



MAN PATĪK

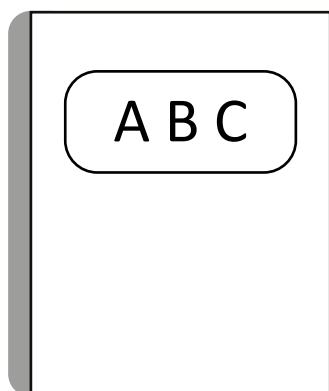

GRĀMATA

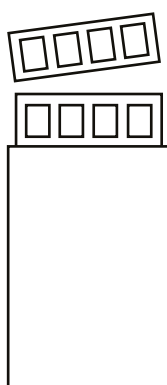

ŠOKOLĀDE

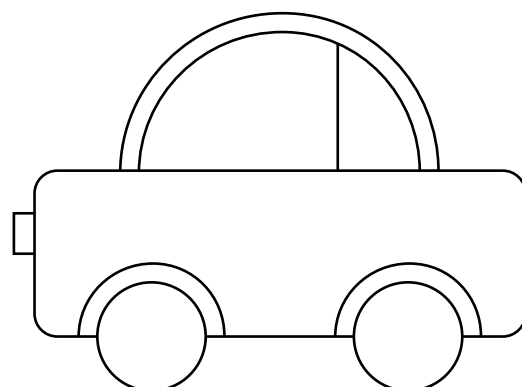

MAŠĪNA

3. Cik daudz svētku!
3.2. Mana vārda diena!

28. darba lapa

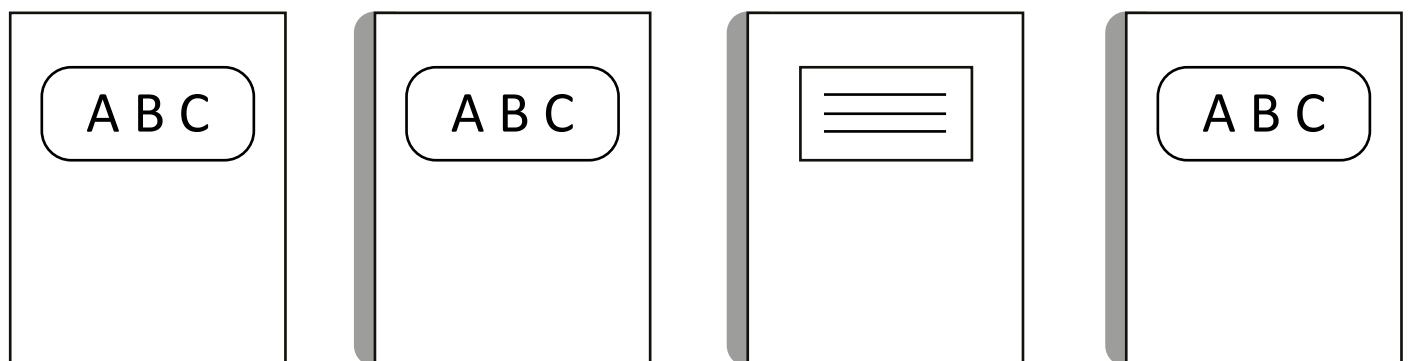
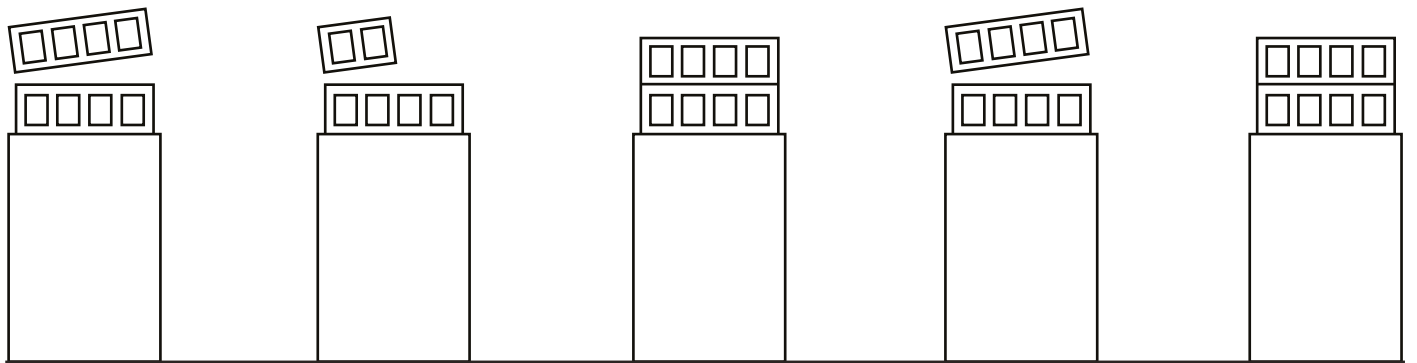
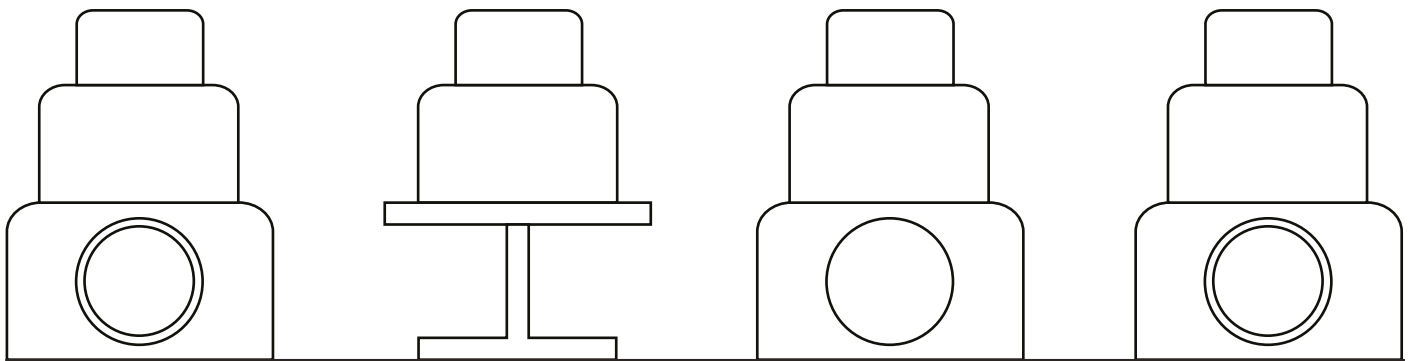
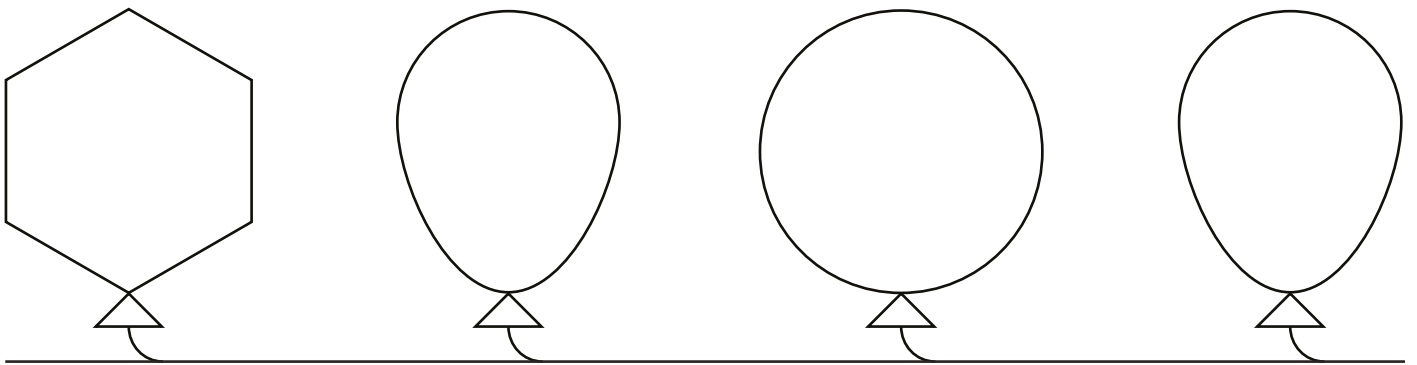
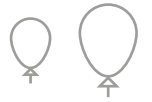

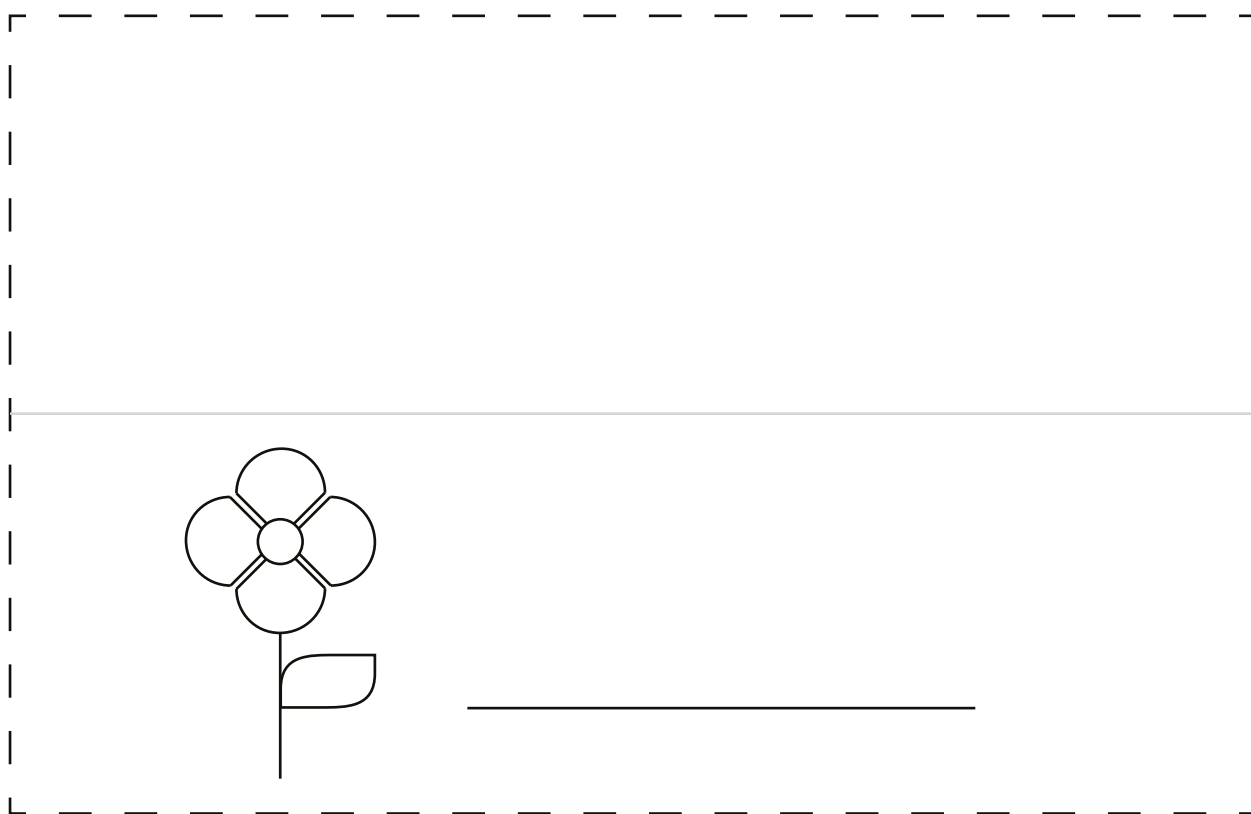
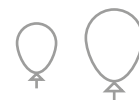

GALDA KARTE



**APSVEICU
VĀRDA DIENĀ!**

APSVEIKUMS

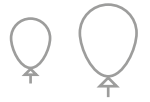

MARTA

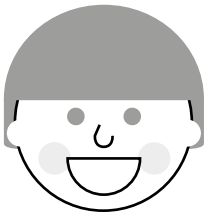

ĒRIKS

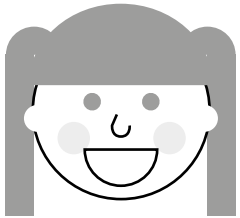

ILZE

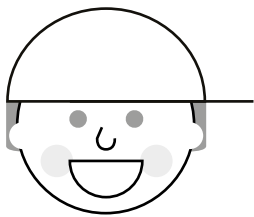

JĀNIS

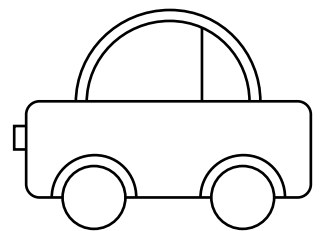
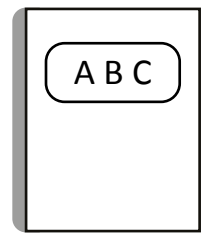
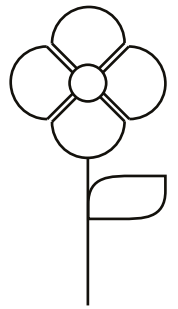
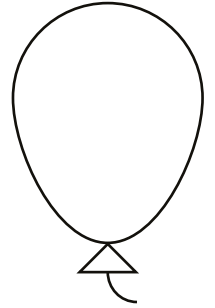
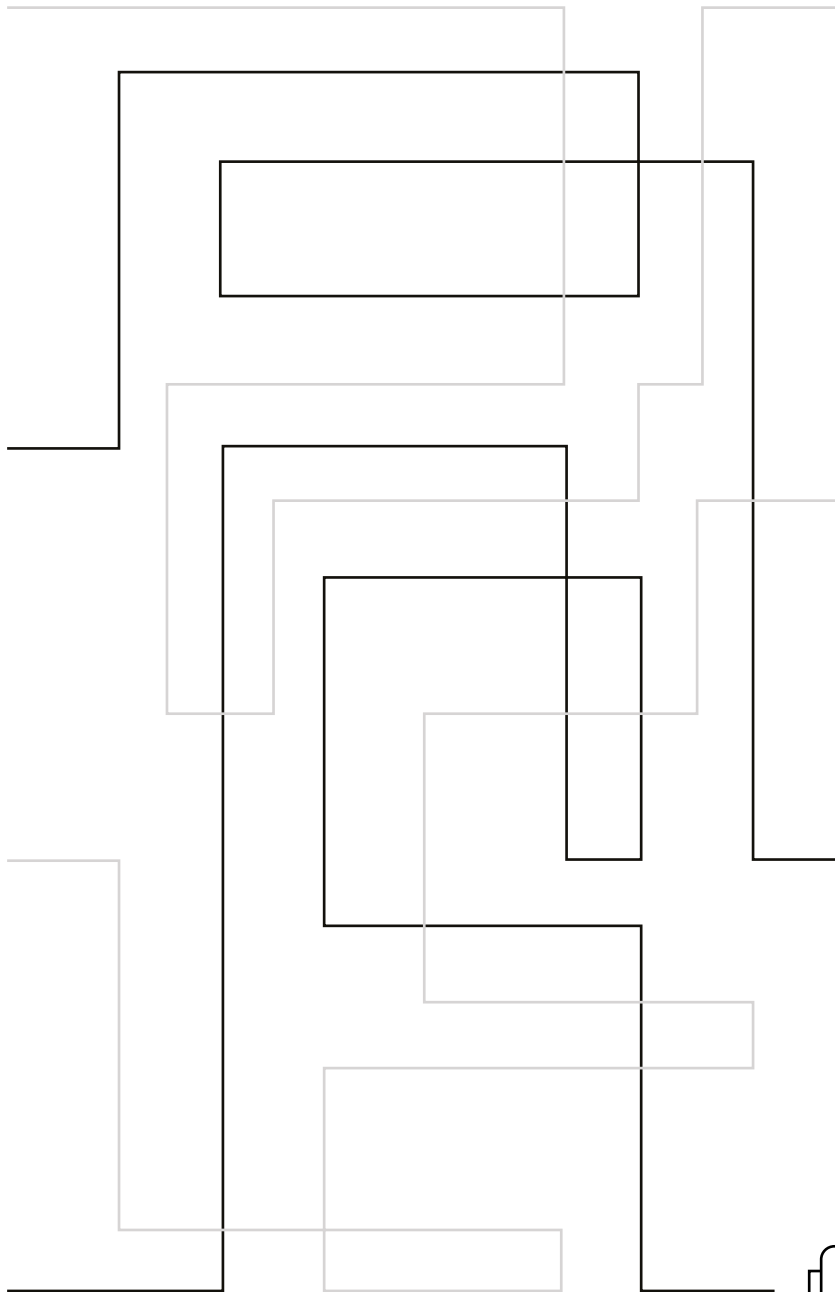



4.1. Nāk rūķītis ar dāvanu maisu

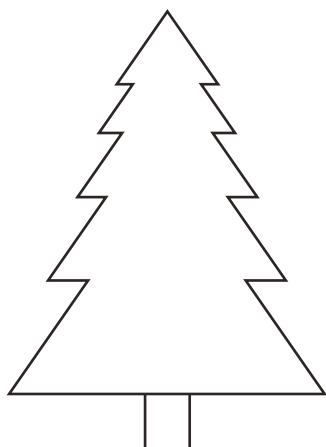

EGLE

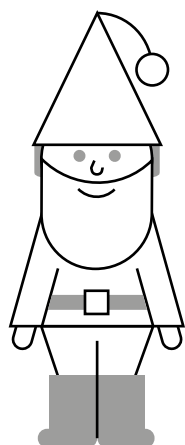

RŪĶIS

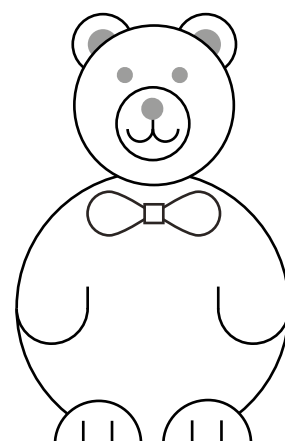

ROTAĻLIETA

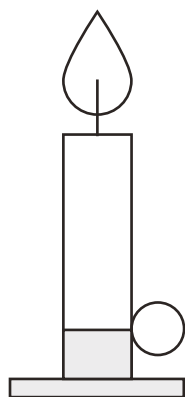
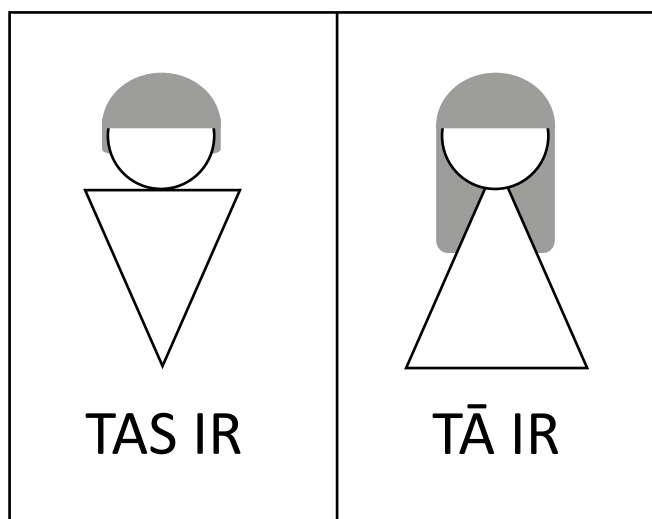

SVECE

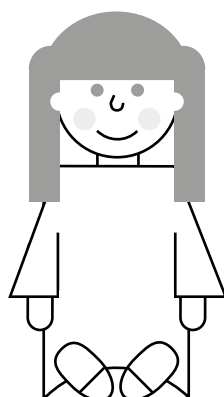

LELLE

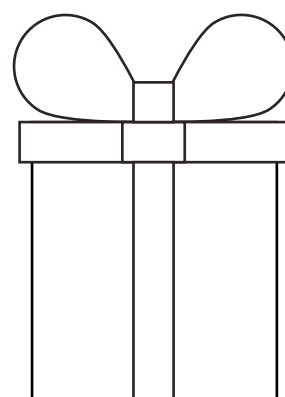

DĀVANA

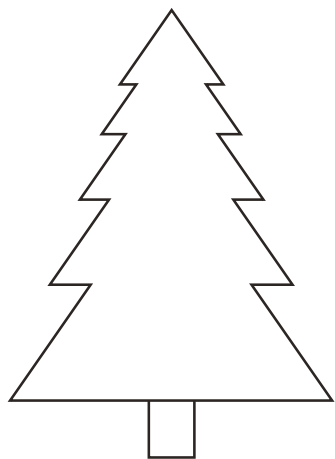

EGLE

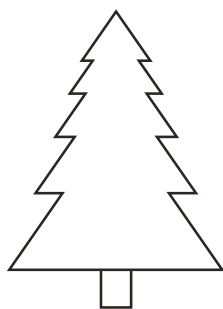

EGLĪTE

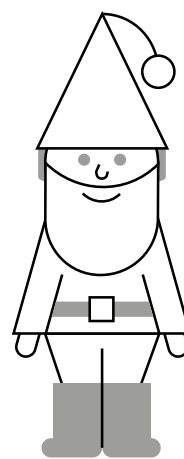

RŪĶIS

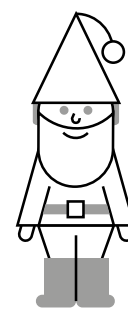

RŪĶĪTIS

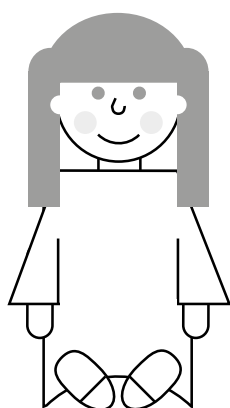

LELLE

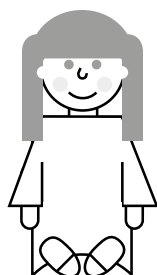

LELLĪTE

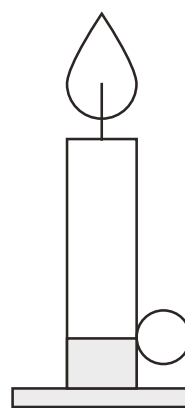

SVECE

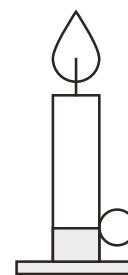

SVECĪTE

4. Gaismas laiks



4.1. Nāk rūķītis ar dāvanu maisu

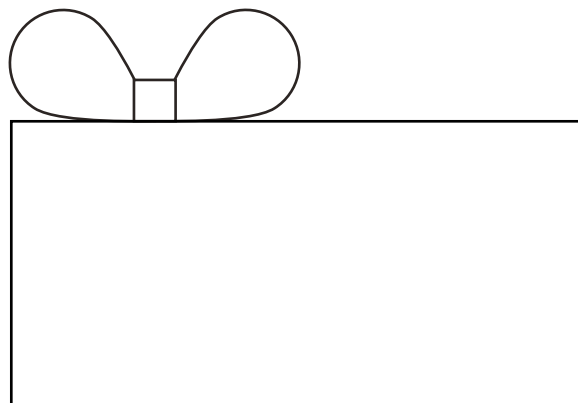
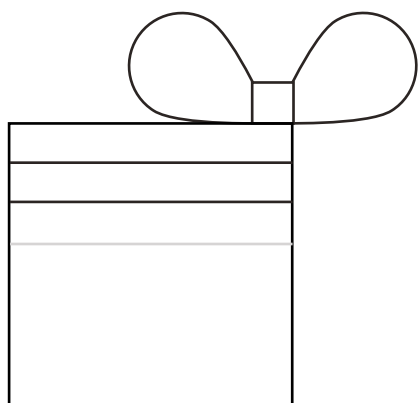
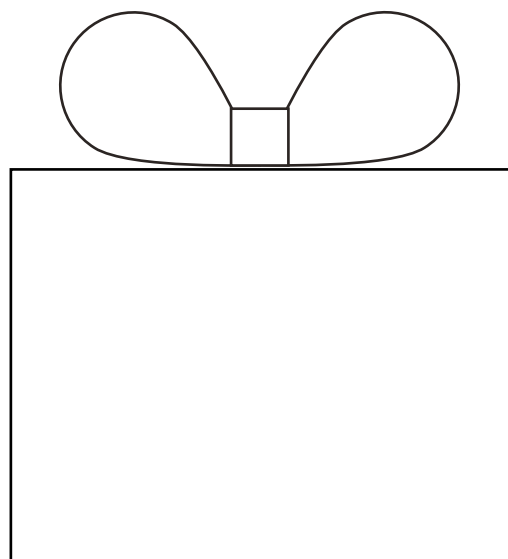
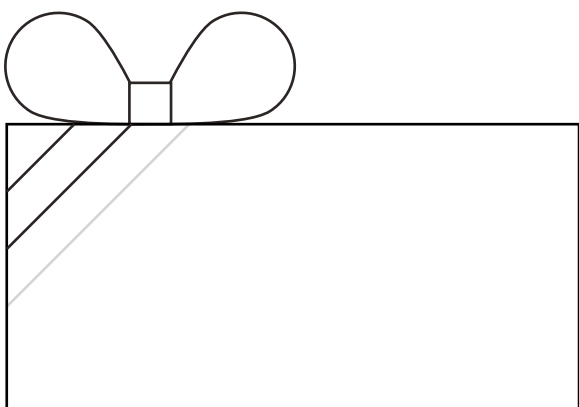
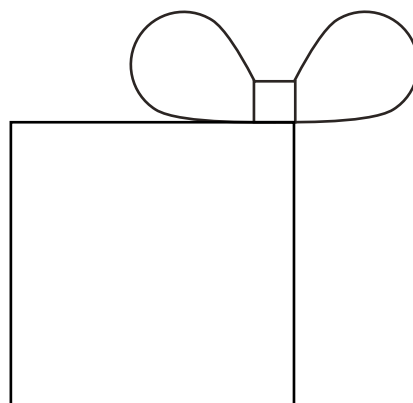
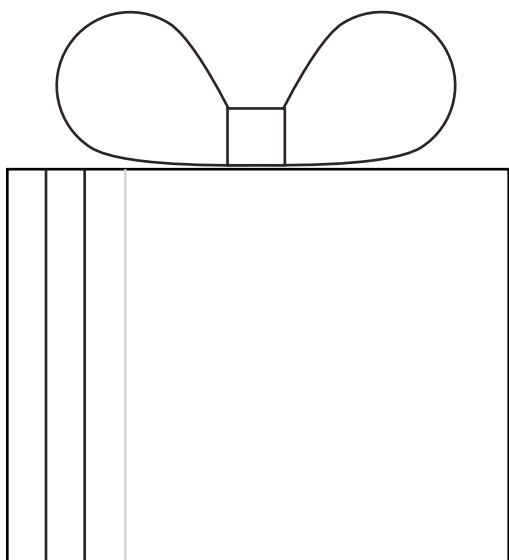



4.1. Nāk rūķītis ar dāvanu maisu

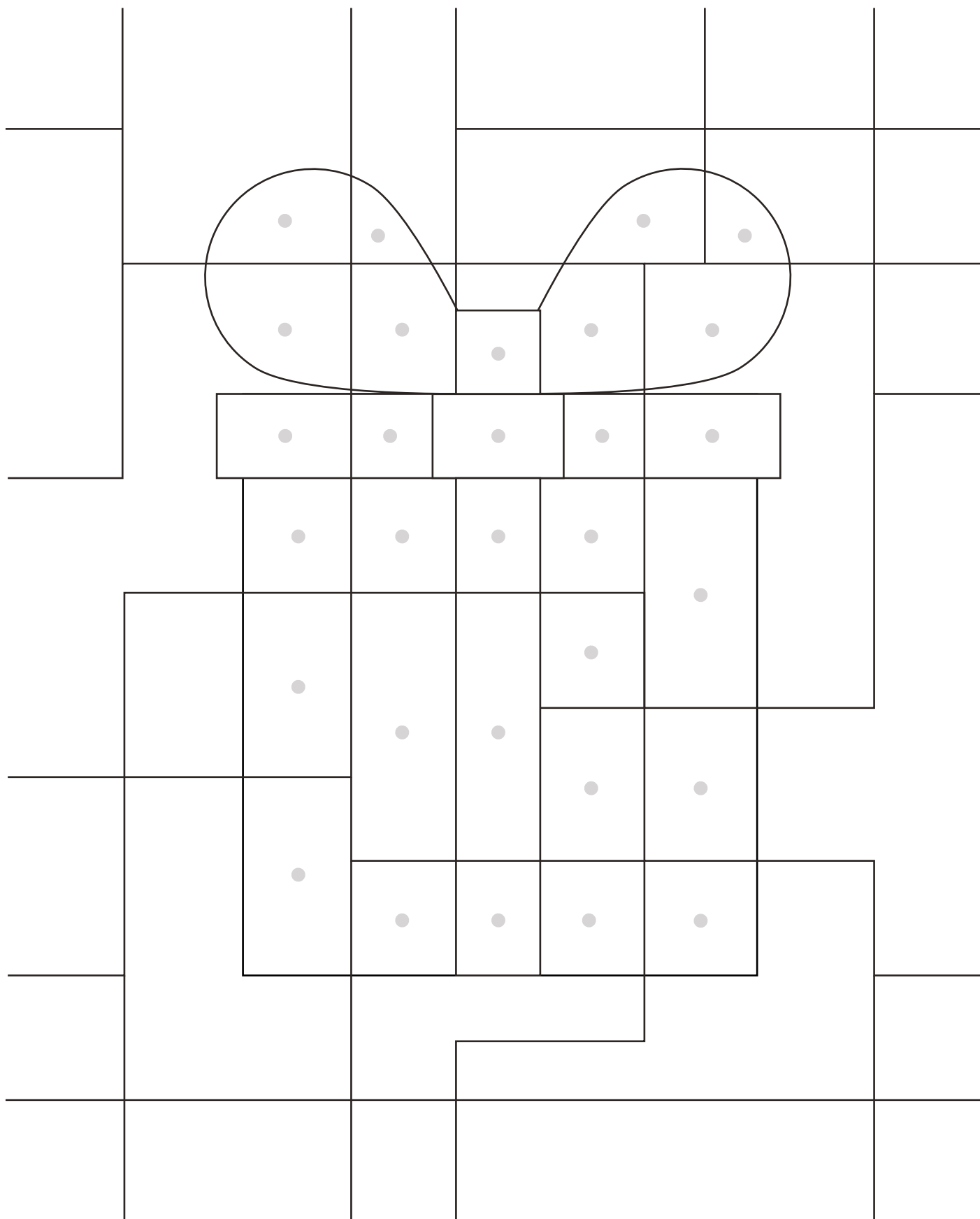



4.1. Nāk rūķītis ar dāvanu maisu

EGLE

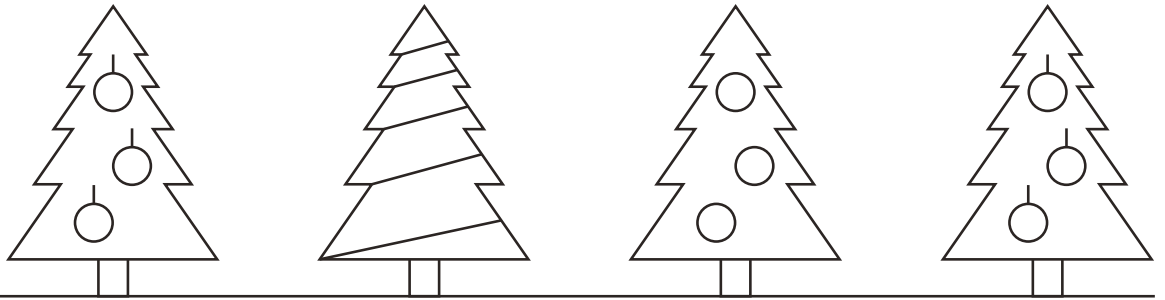

LĀCIS

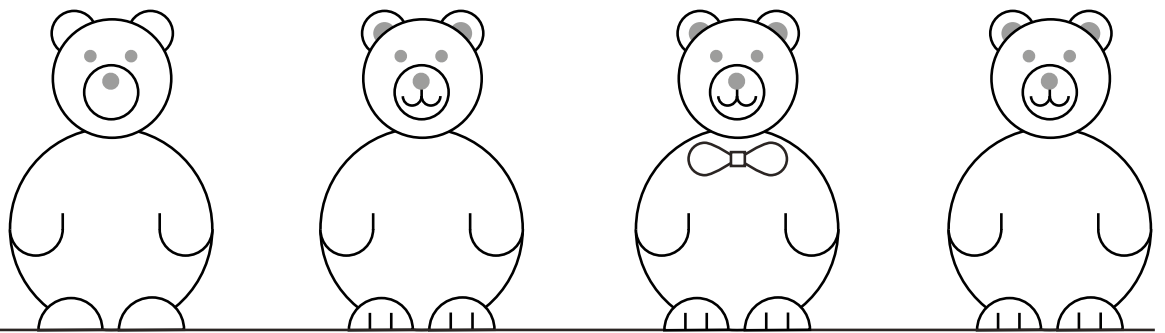

ZAĶIS

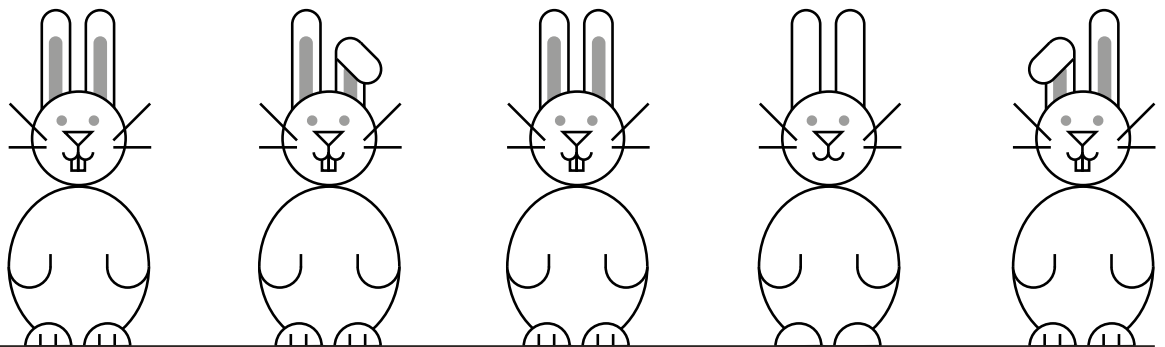

RŪĶIS

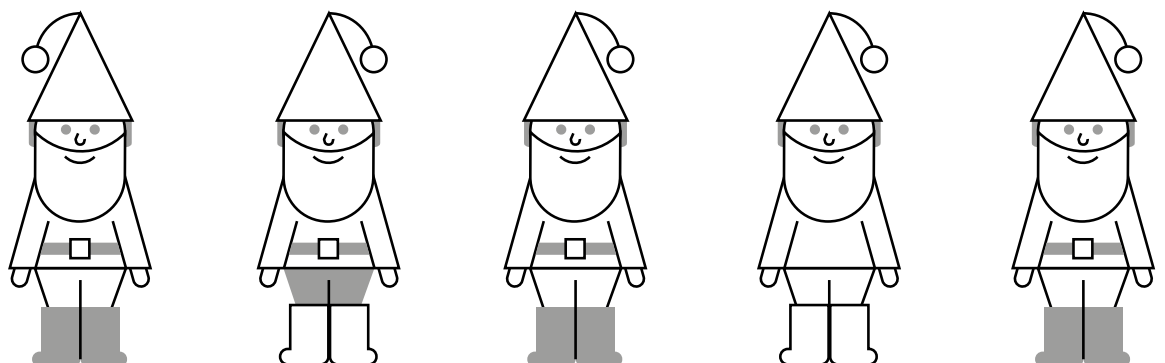

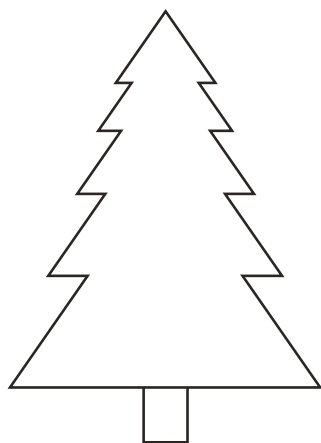

EGLE

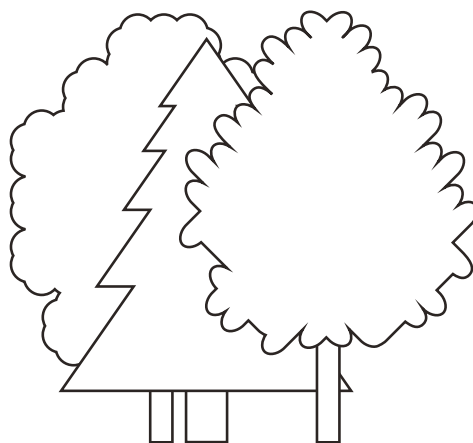

MEŽS

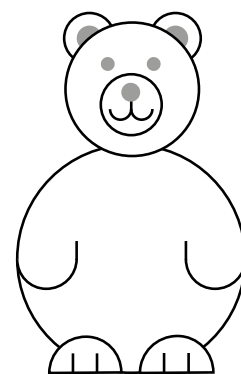

LĀCIS

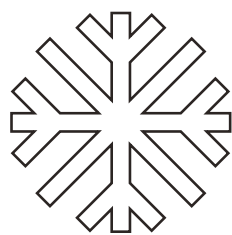

SNIEGPĀRSLA

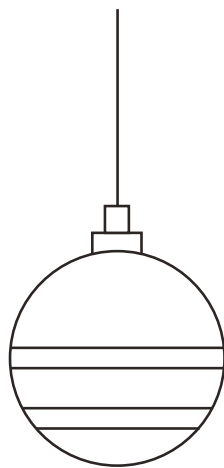

ROTĀJUMS

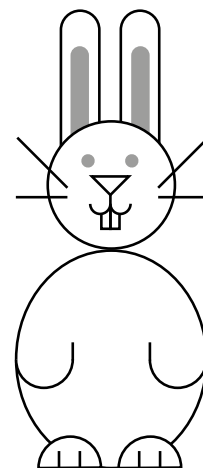

ZAČIS

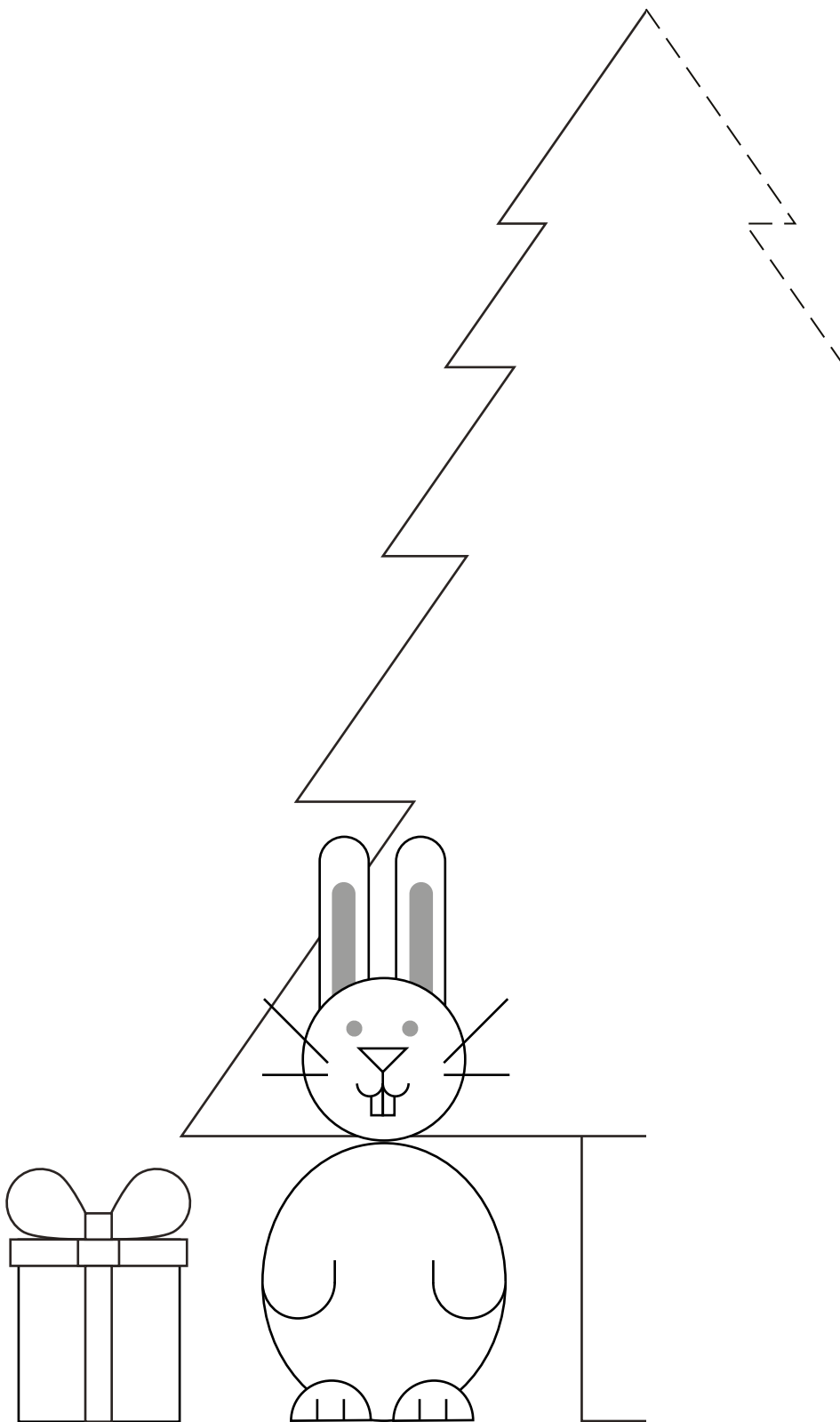
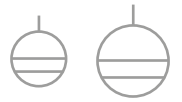

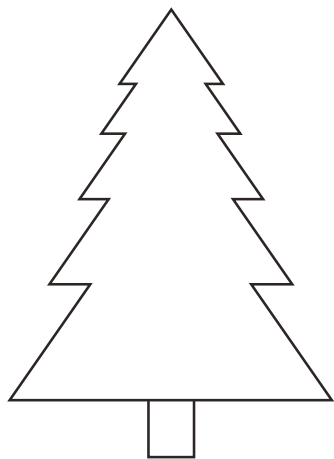

EGLE

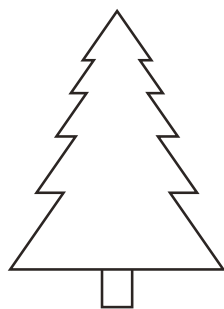

EGLĪTE

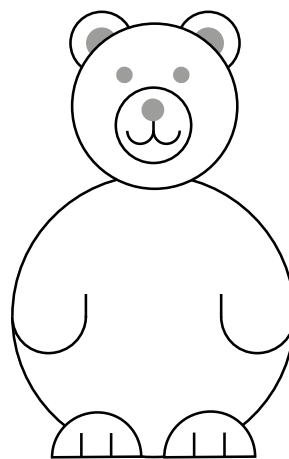

LĀCIS

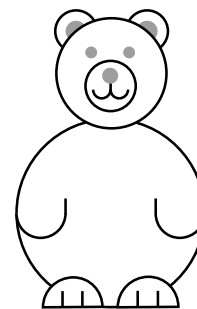

LĀCĪTIS

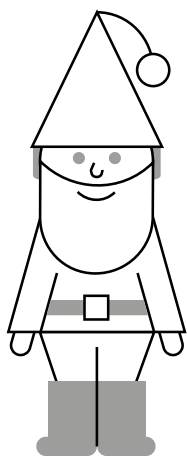

RŪKIS

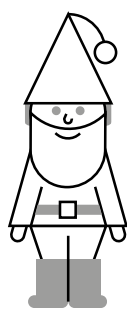

RŪKĪTIS



ZAĶIS



ZAĶĪTIS

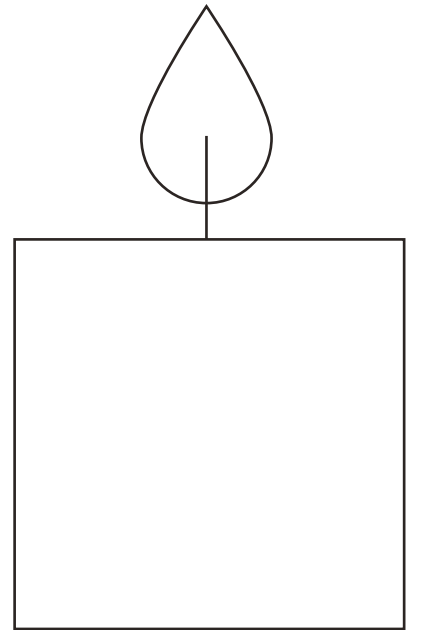
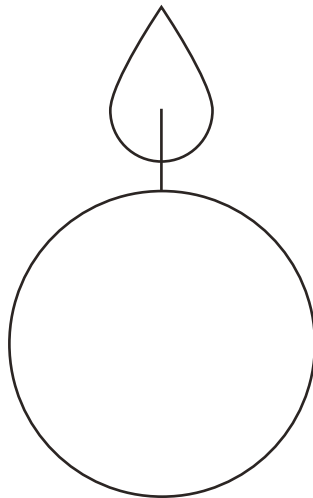
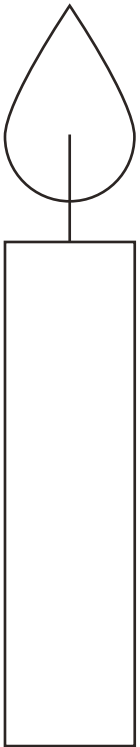
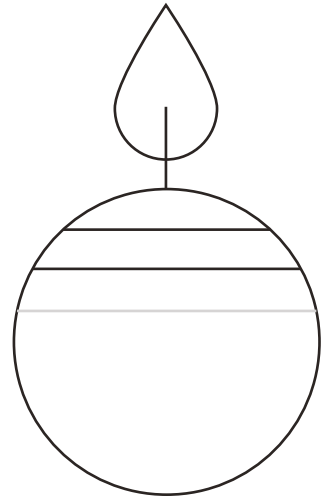
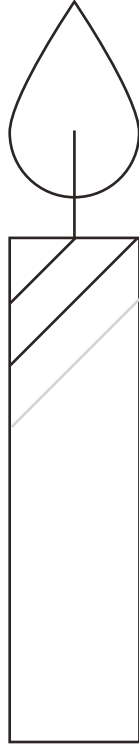
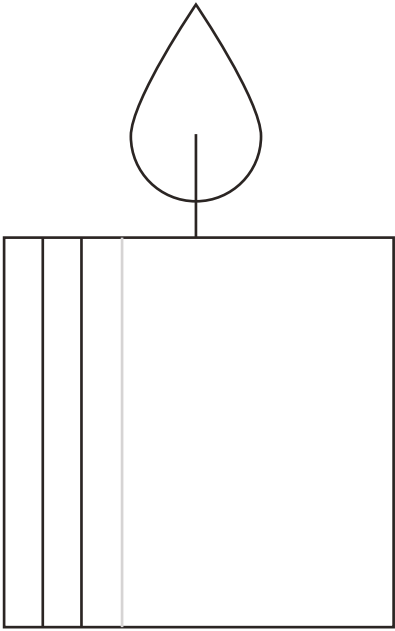
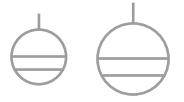

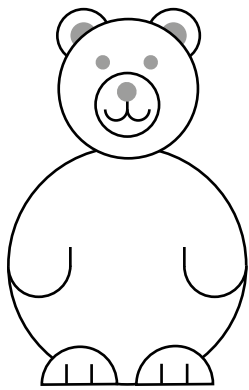
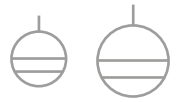

2

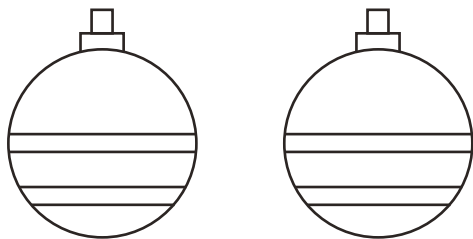
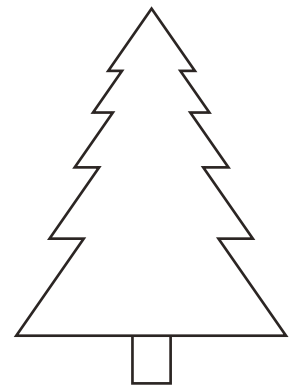

4

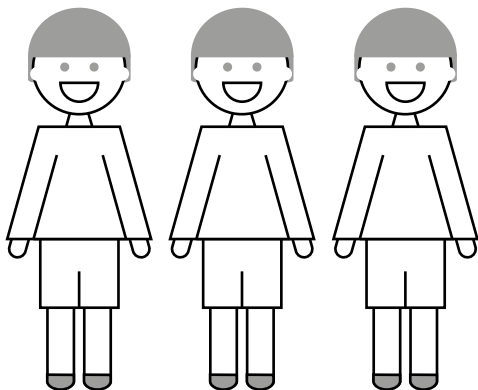
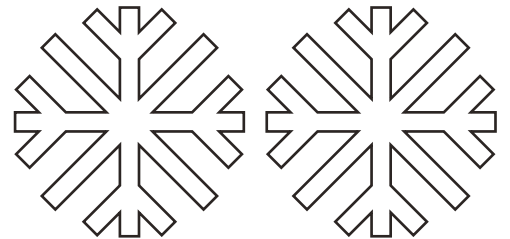

1

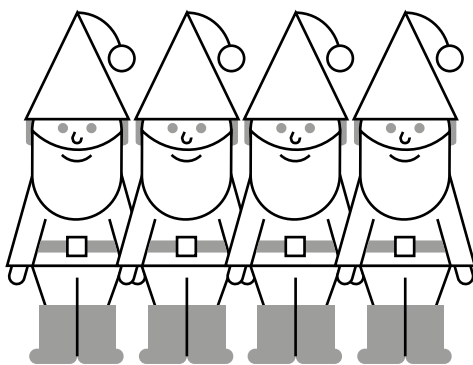
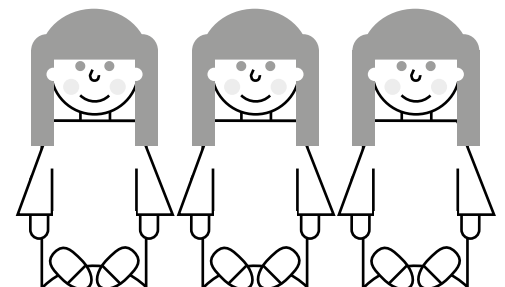

5

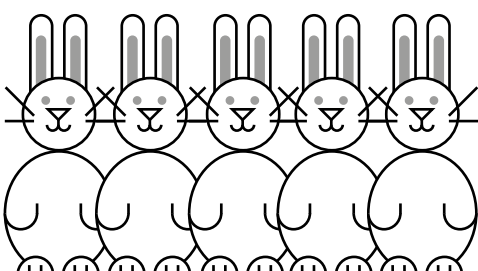
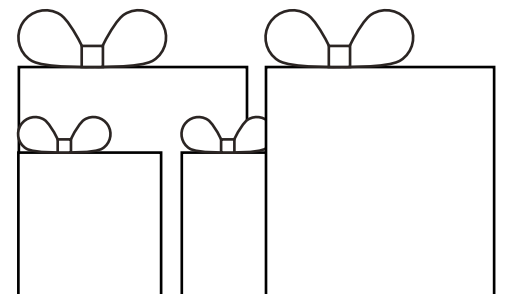

3

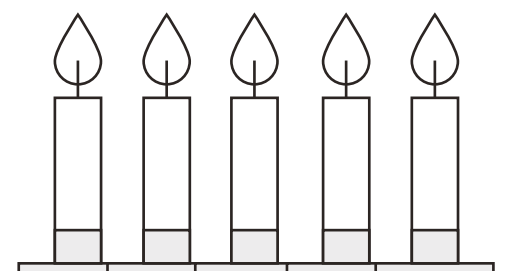

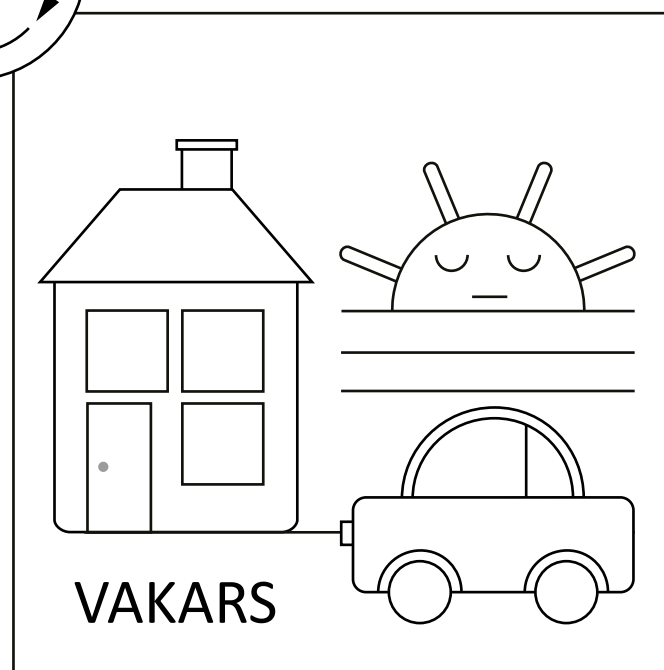
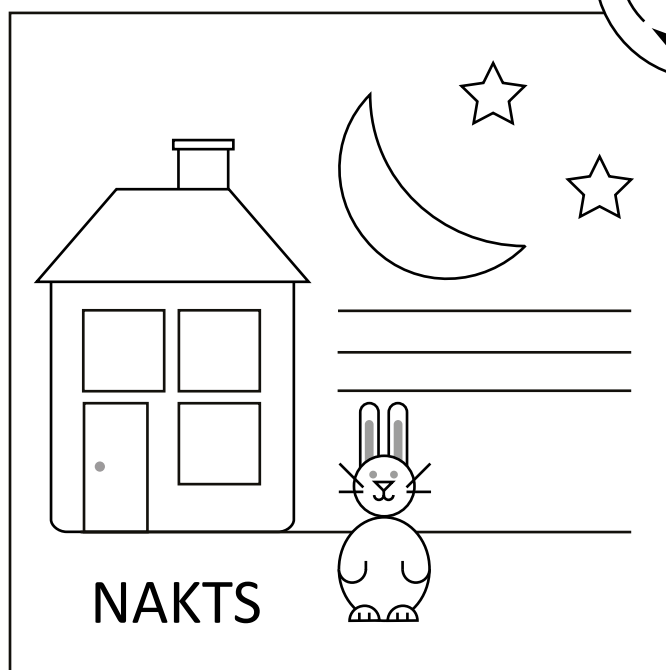
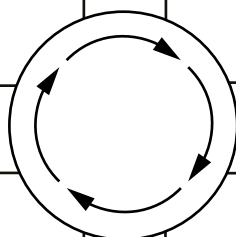
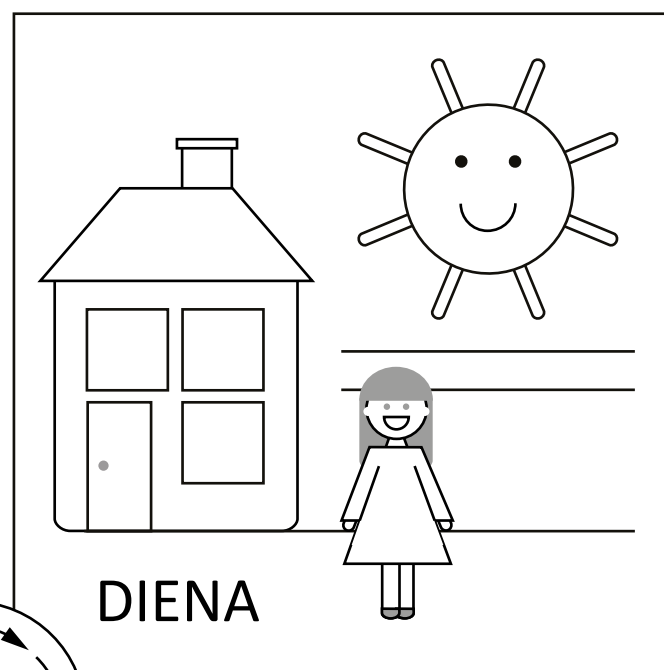
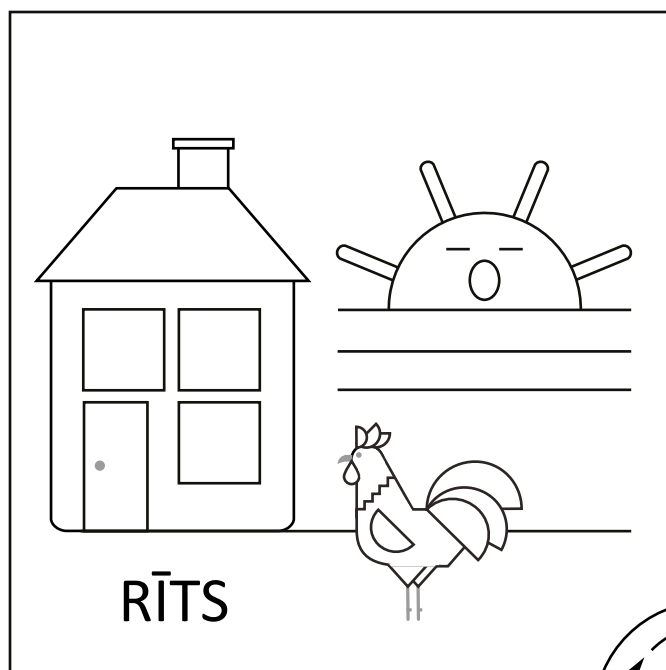



5.1. Diena un nakts

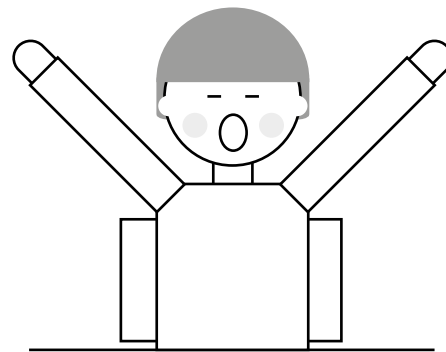
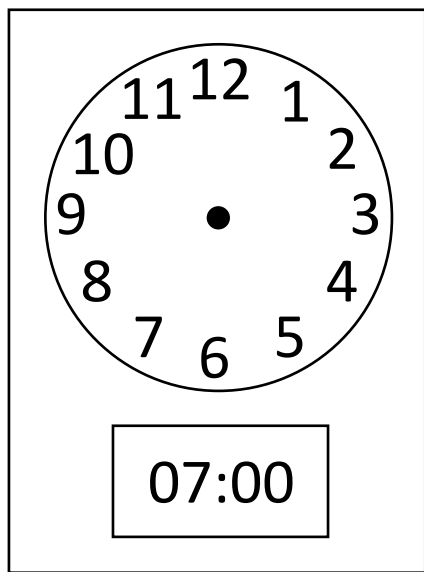

PAMOSTOS

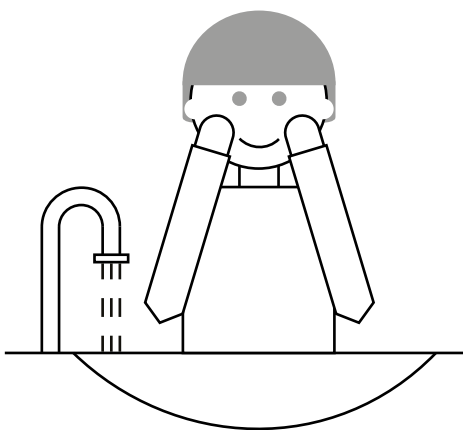

MAZGĀJOS

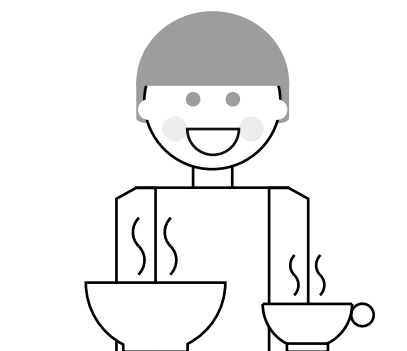

BROKASTOJU

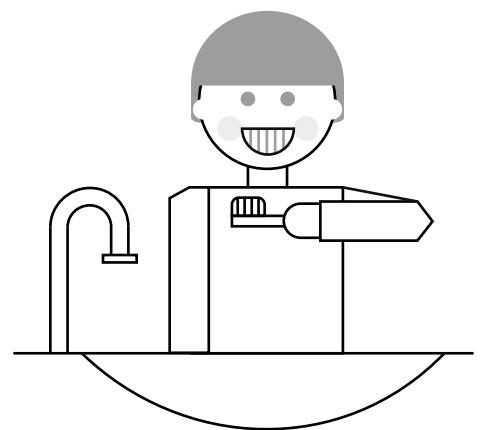

TĪRU ZOBUS

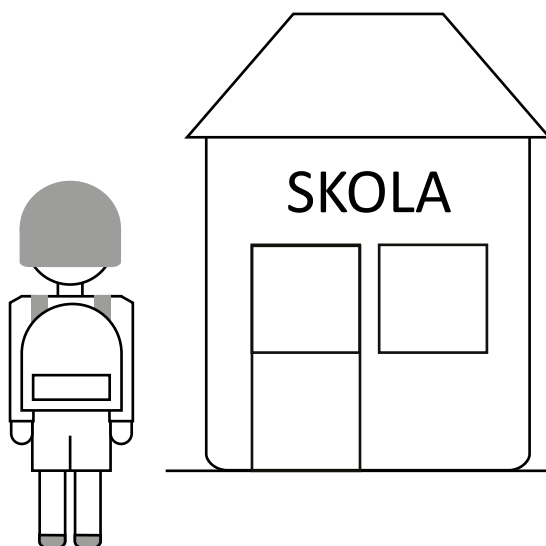

EJU UZ SKOLU

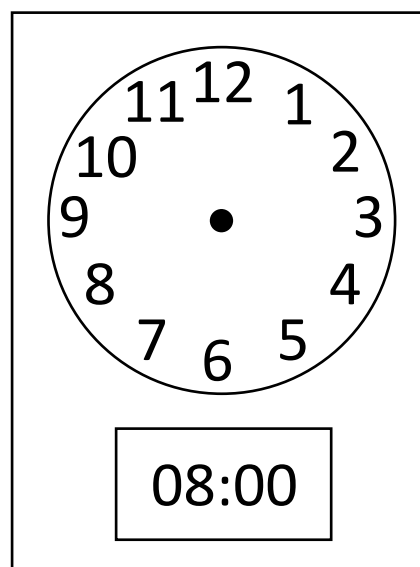

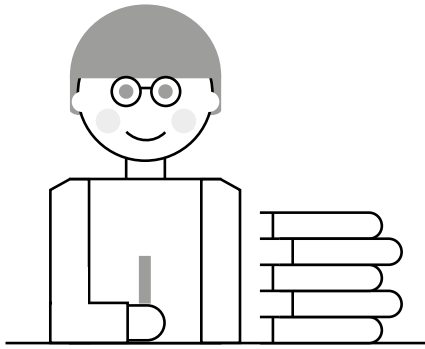

MĀCOS

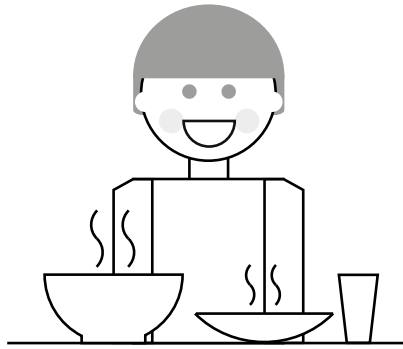

PUSDIENOJU

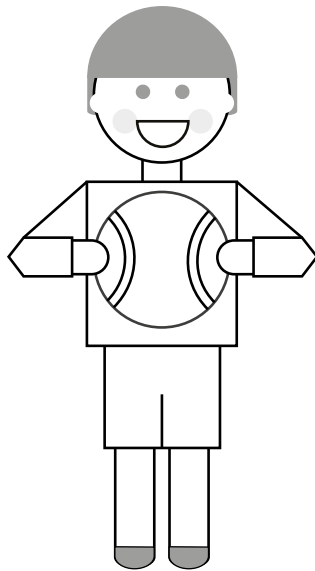
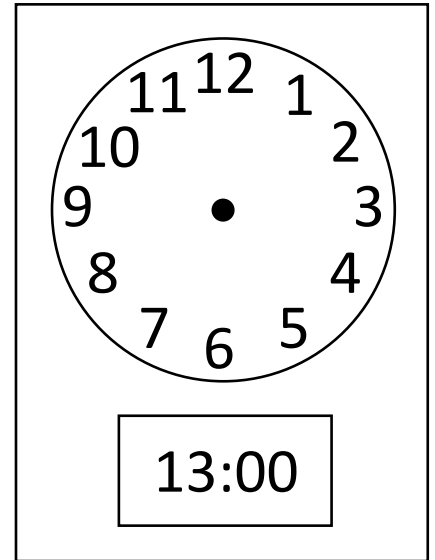

APMEKLĒJU
SPORTA PULCIŅU

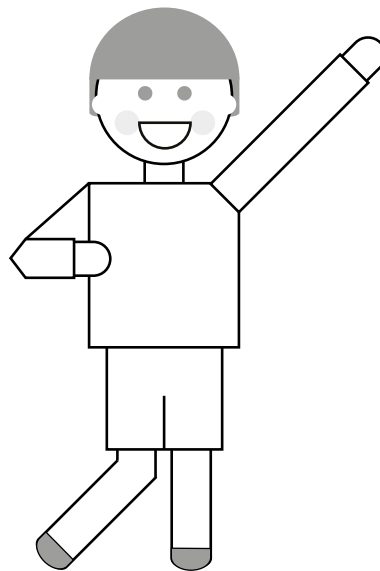

DEJOJU

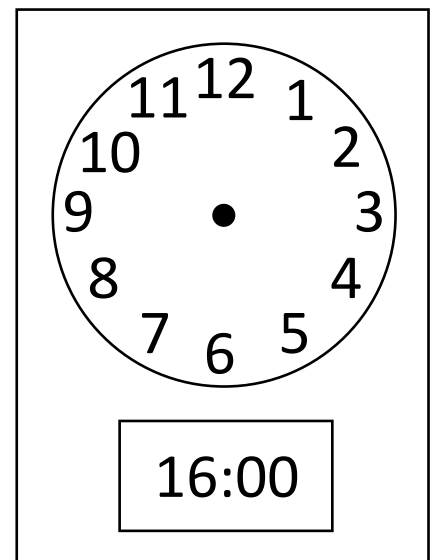

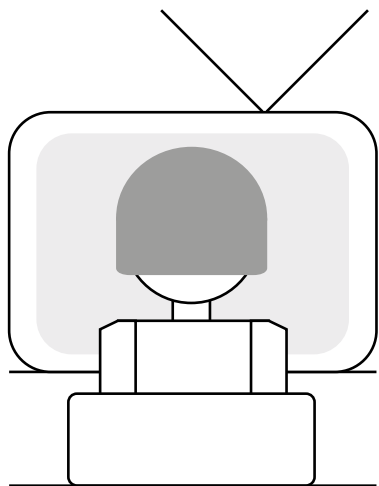

SKATOS FILMU

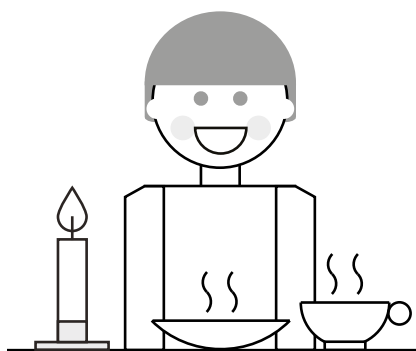

VAKARIŅOJU

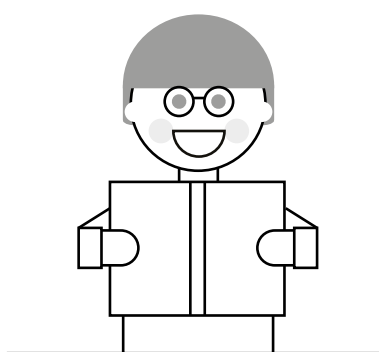
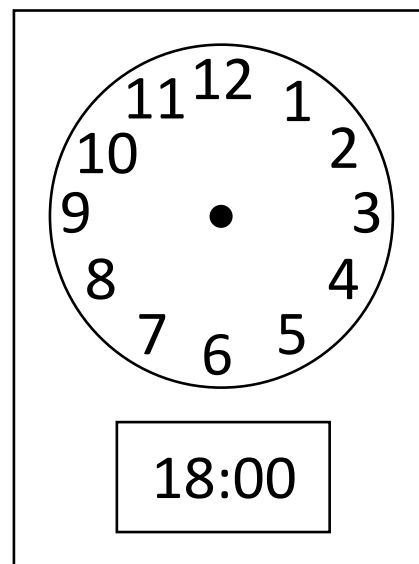

LASU

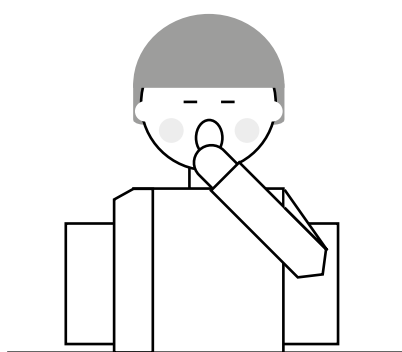

EJU GULĒT

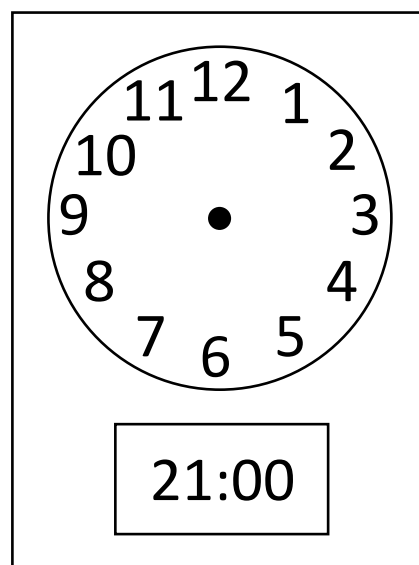



5.1. Diena un nakts

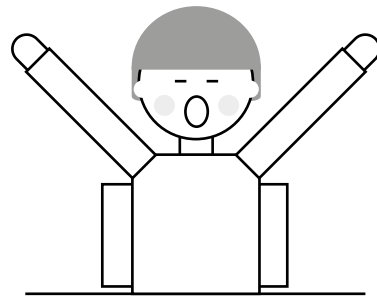
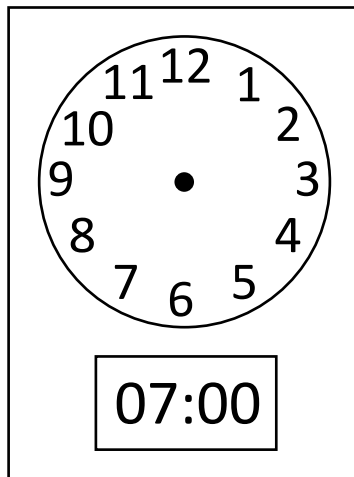

PAMOSTOS

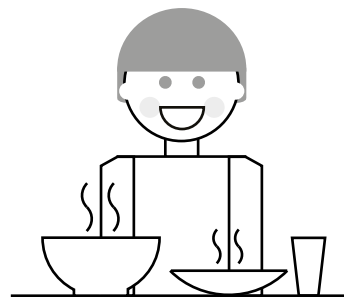

PUSDIENOJU

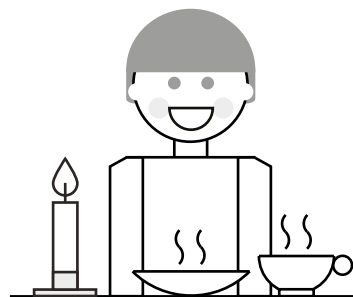
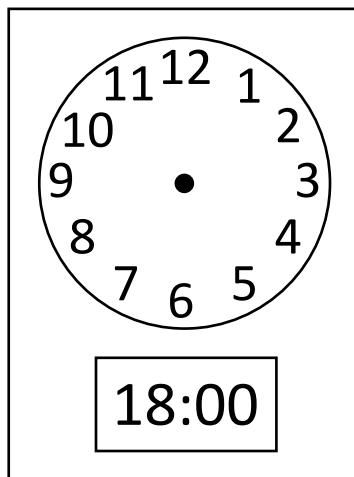
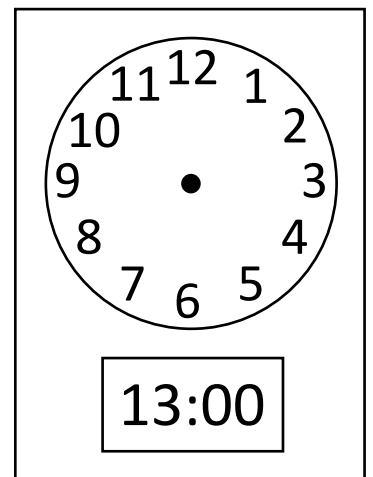

VAKARIŅOJU

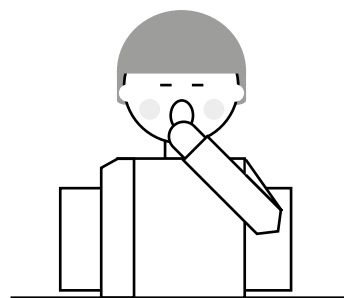

EJU GULĒT

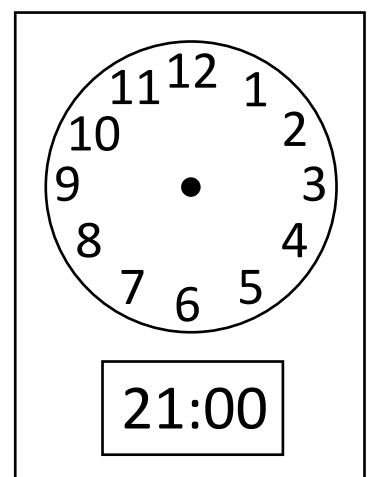

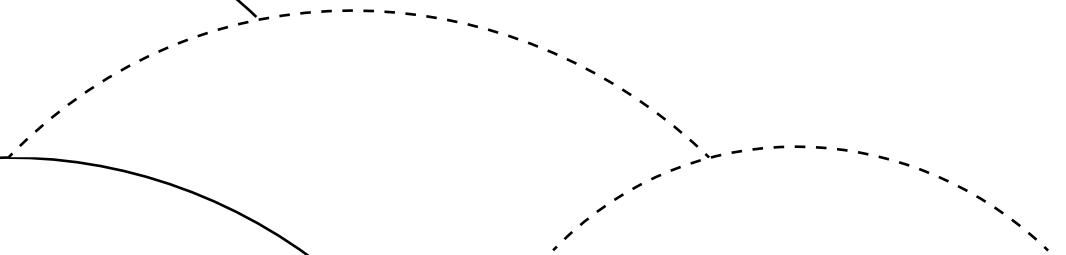
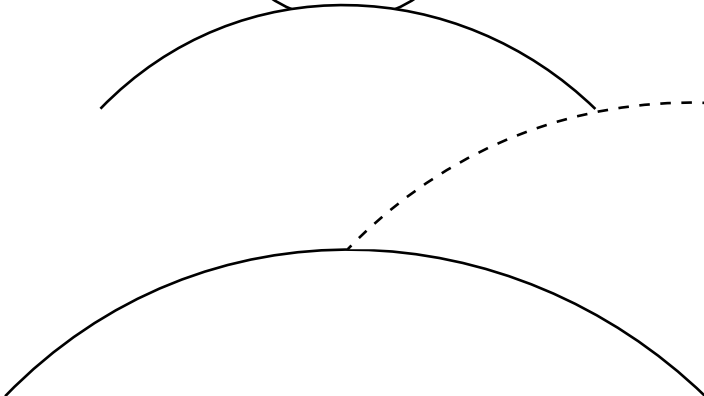
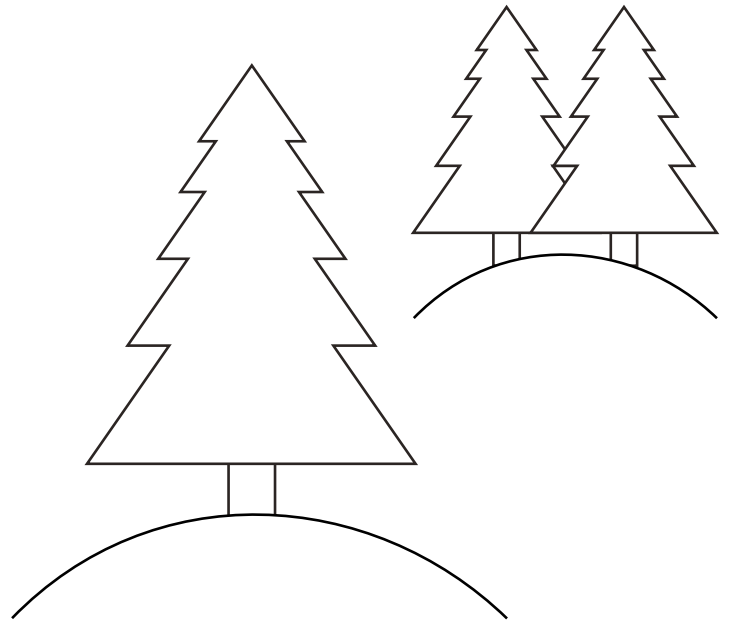
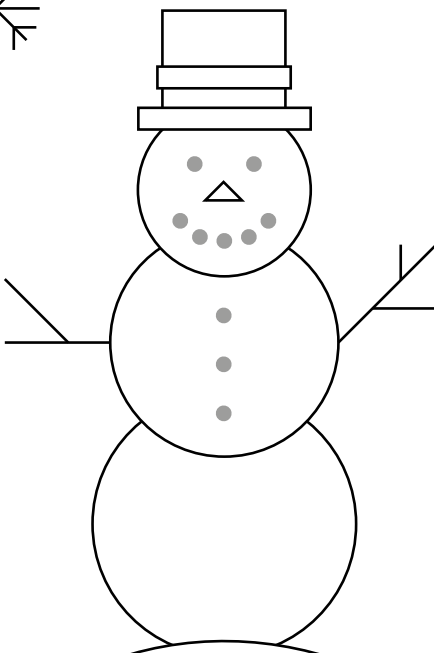
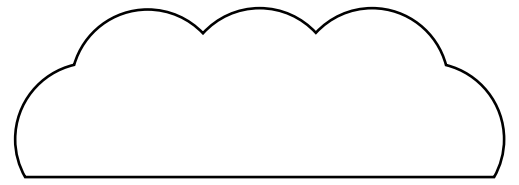
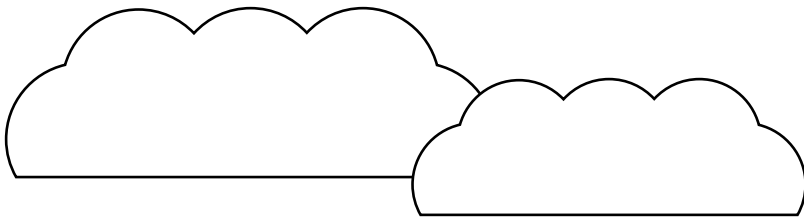

ZIEMA

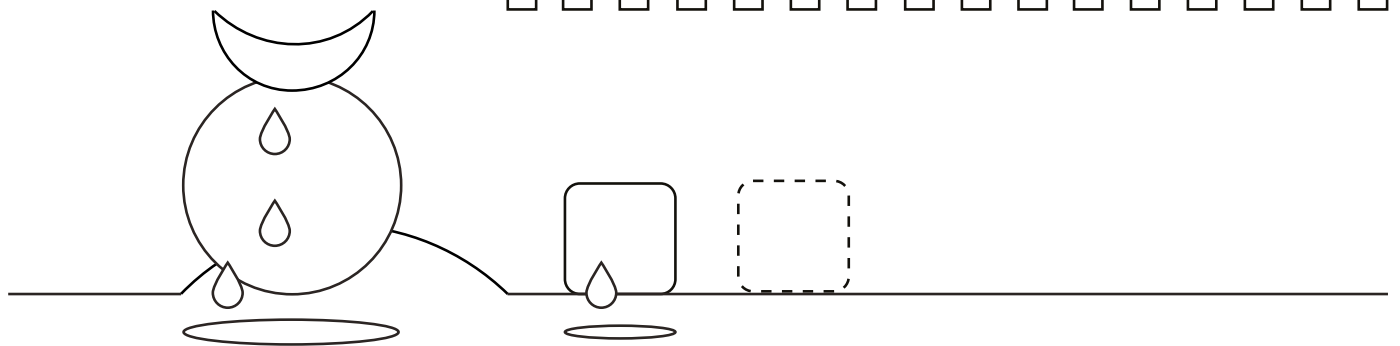
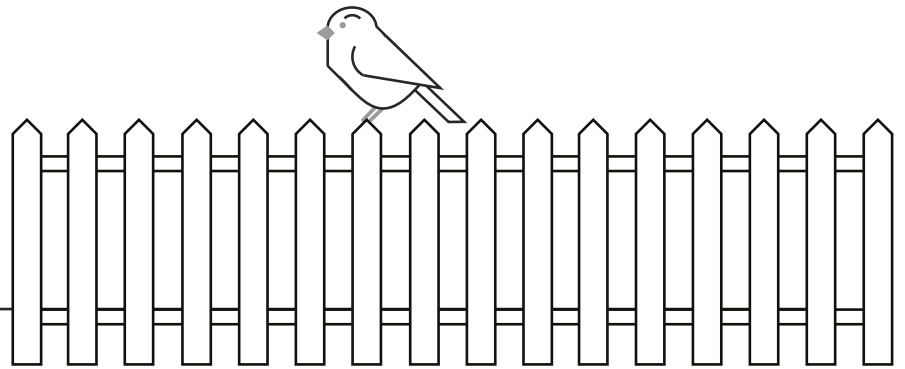
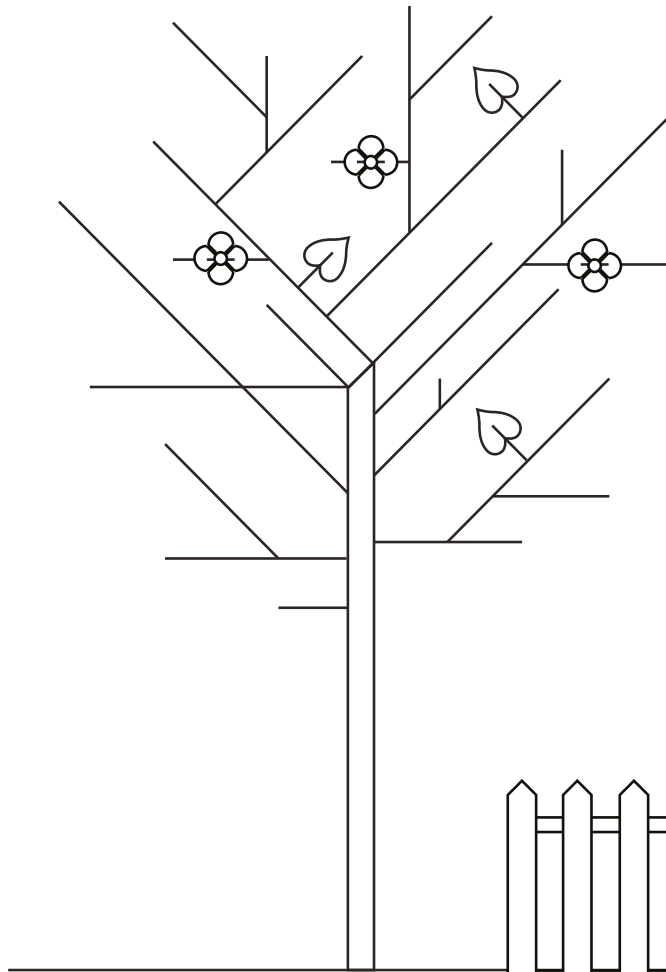
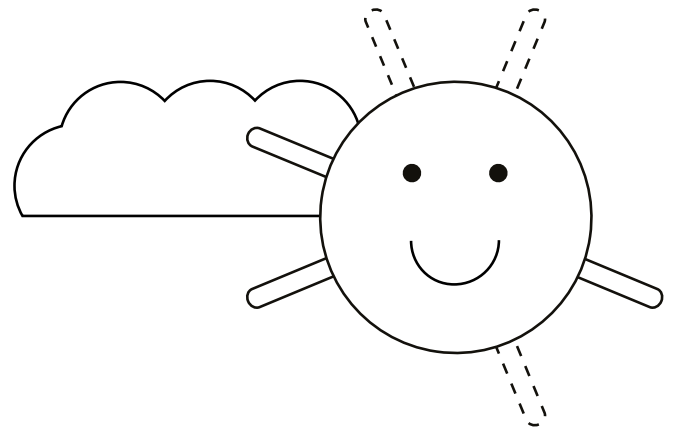
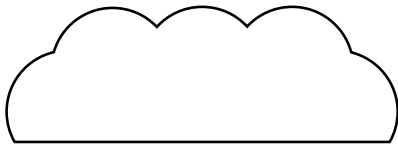

PAVASARIS _____

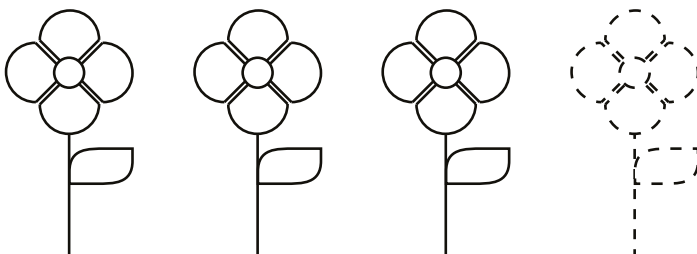
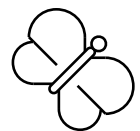
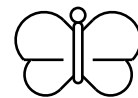
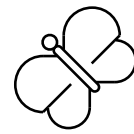
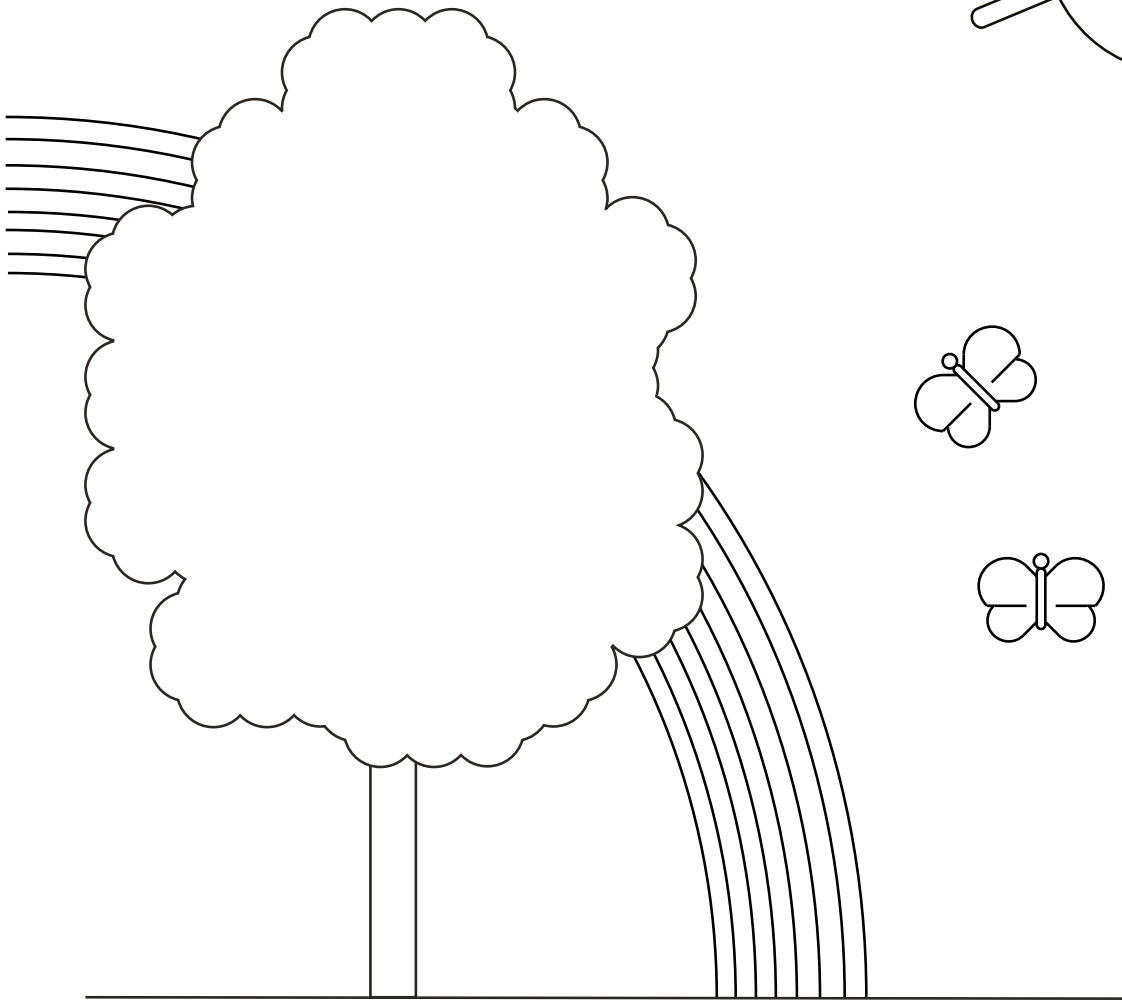
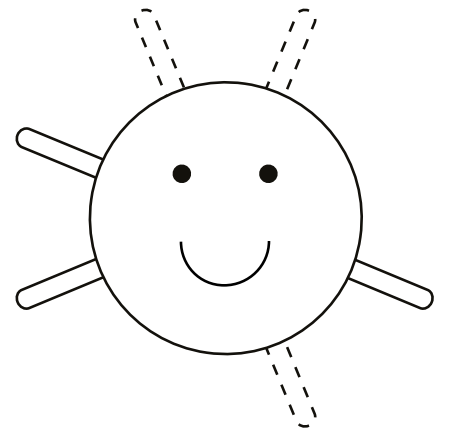

VASARA

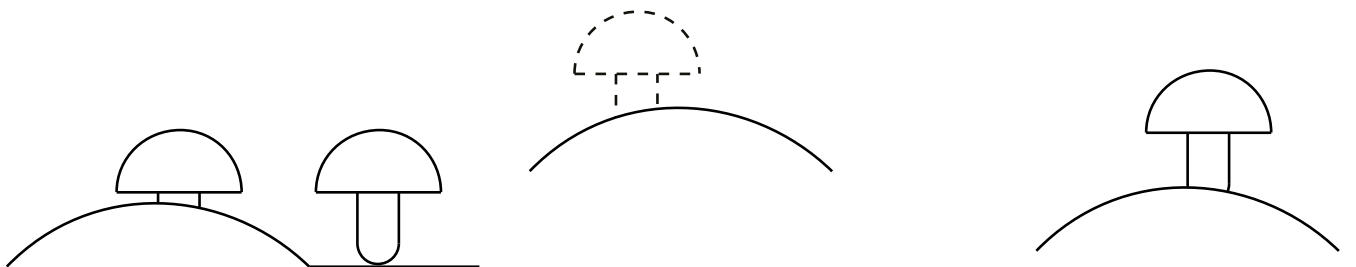
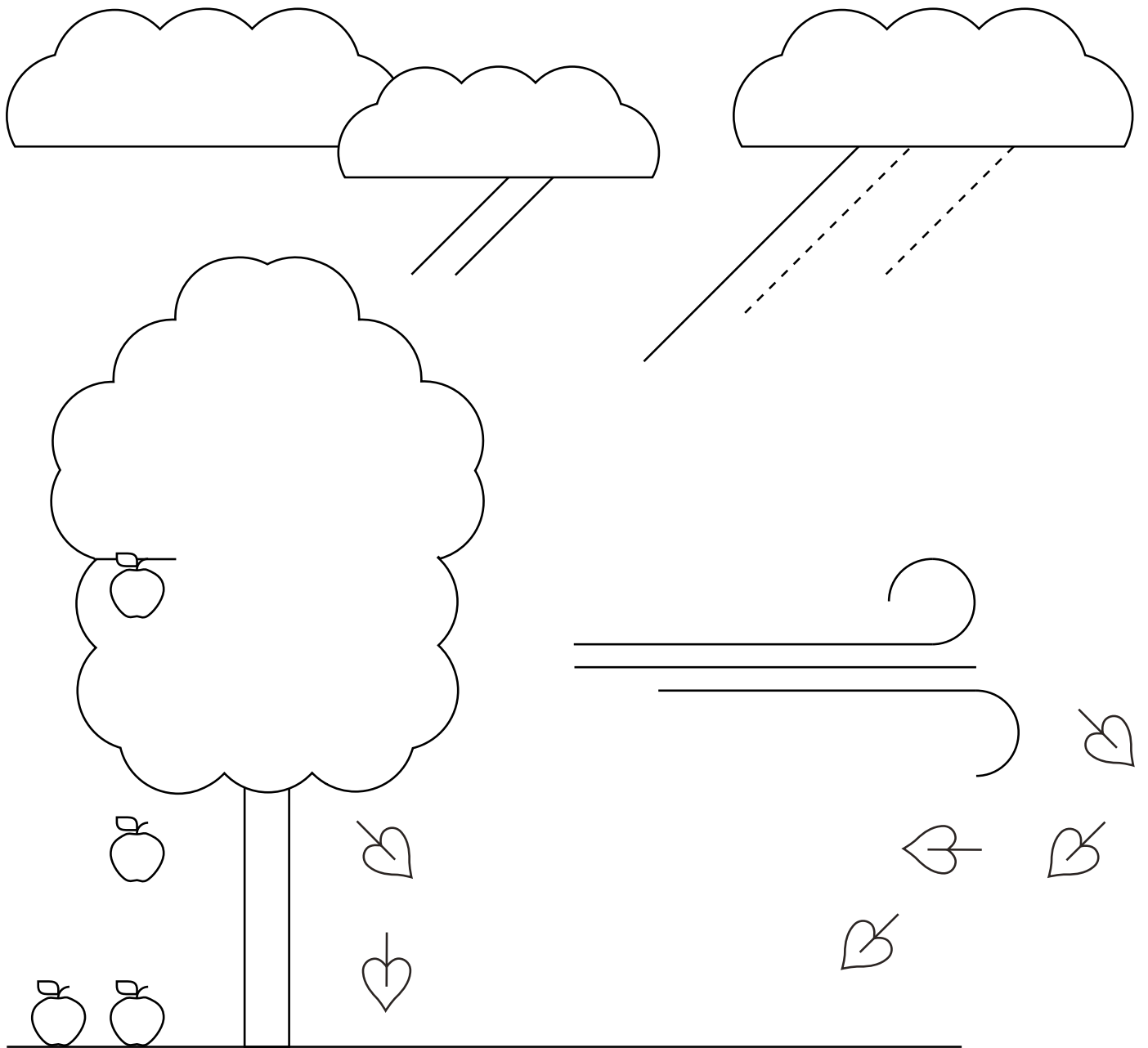

RUDENS _____

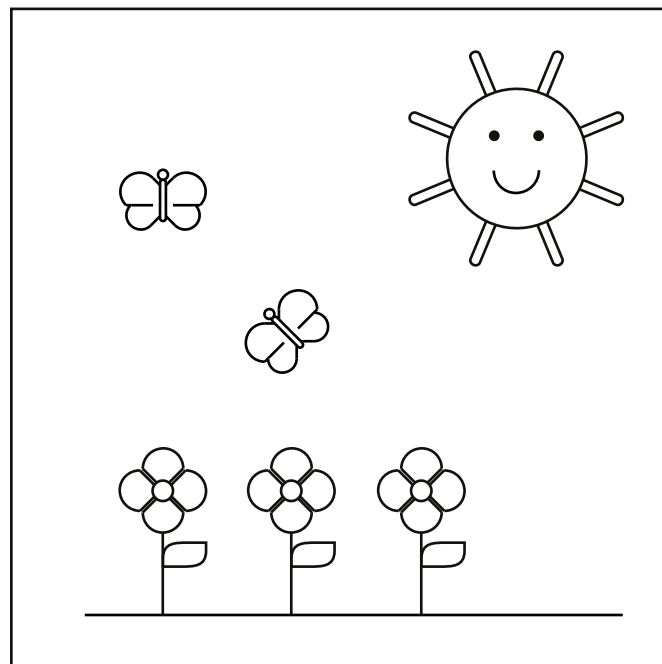
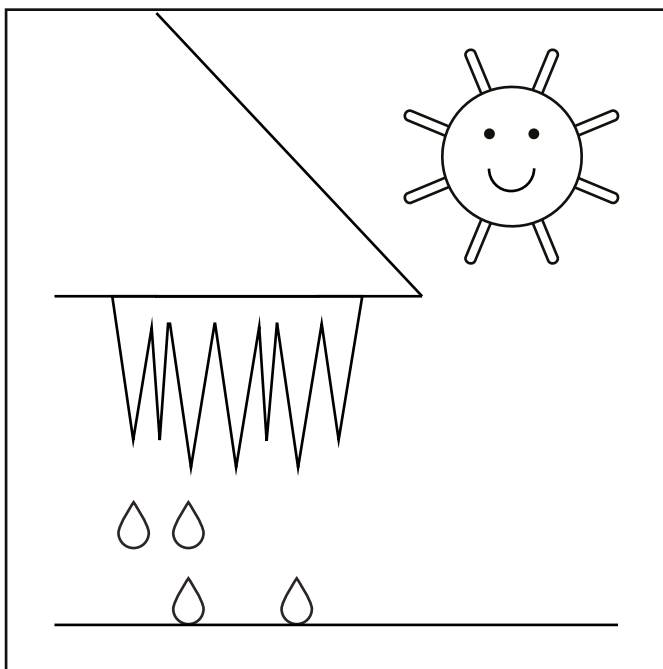

ZIEMA PAVASARIS

VASARA RUDENS

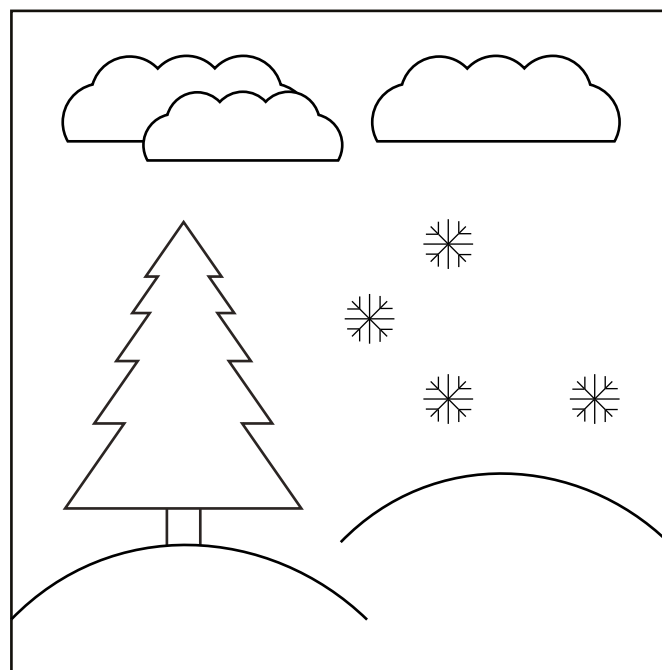
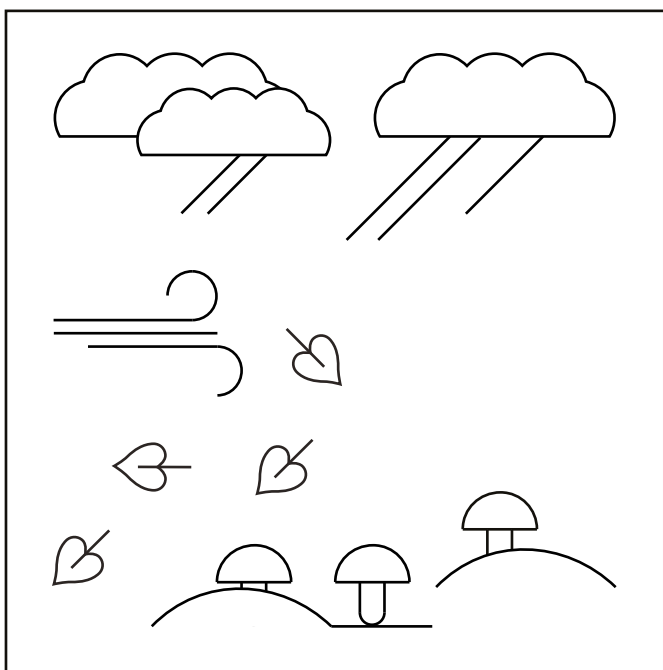

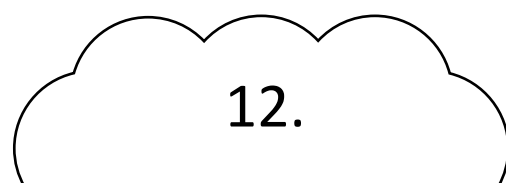
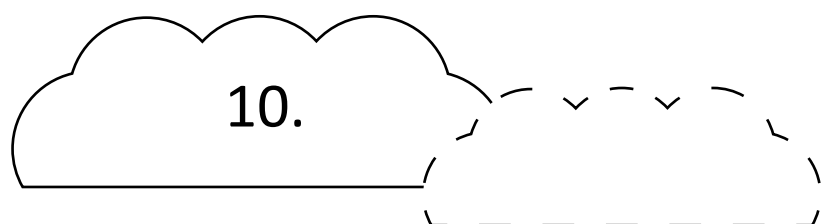
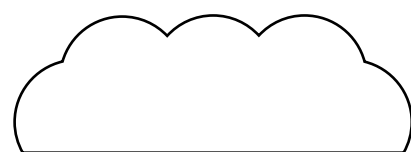
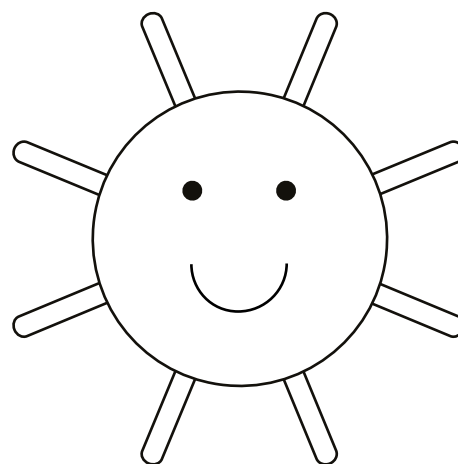
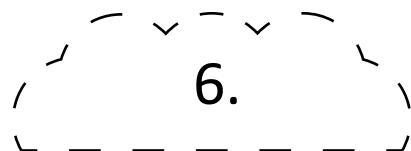
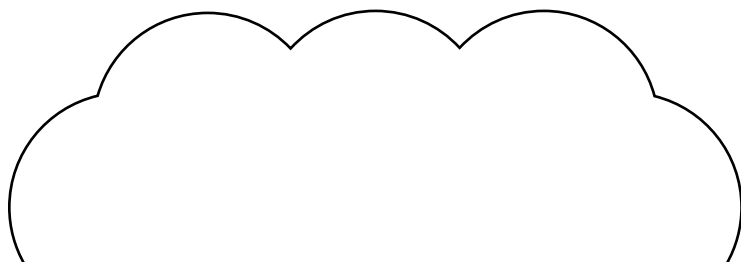
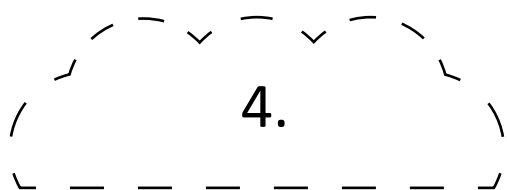
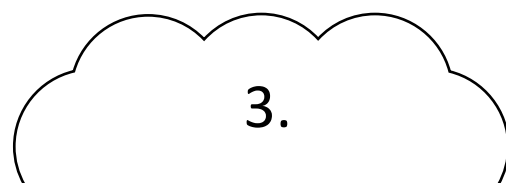

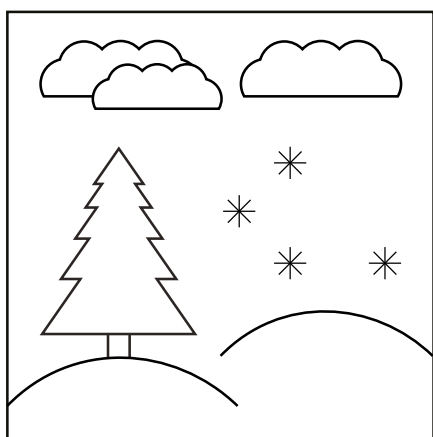

ZIEMA

JANVĀRIS

FEBRUĀRIS

MARTS

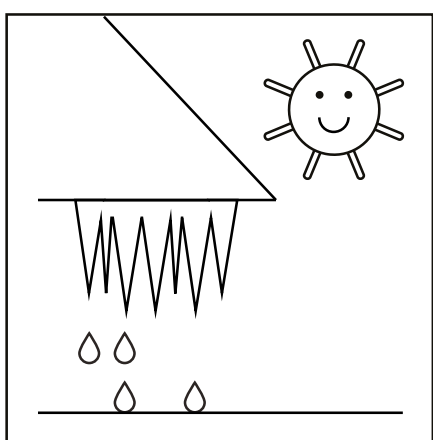

PAVASARIS

APRĪLIS

MAIJS

JŪNIJS

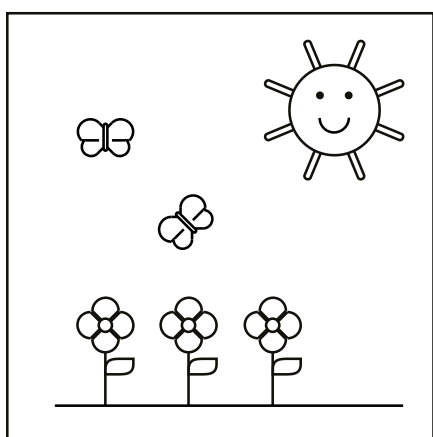

VASARA

JŪLIJS

AUGUSTS

SEPTEMBRIS

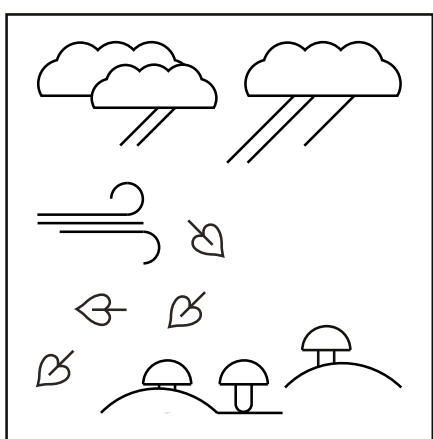

RUDENS

OKTOBRIS

NOVEMBRIS

DECEMBRIS

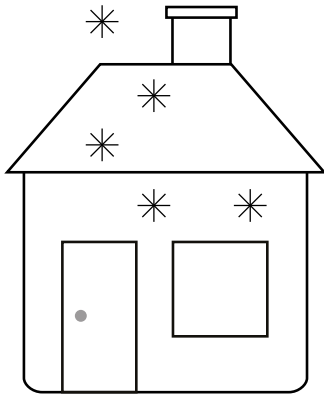

ZIEMAS MĒNEŠI IR:

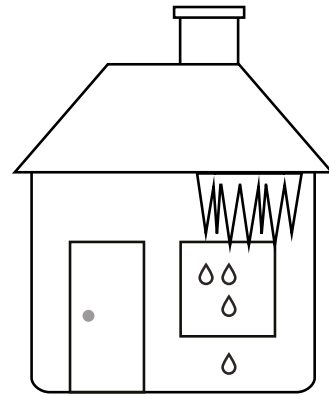

PAVASARA MĒNEŠI IR:

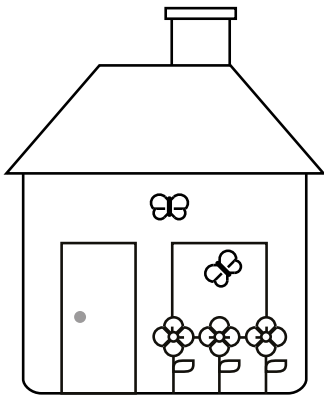

VASARAS MĒNEŠI IR:

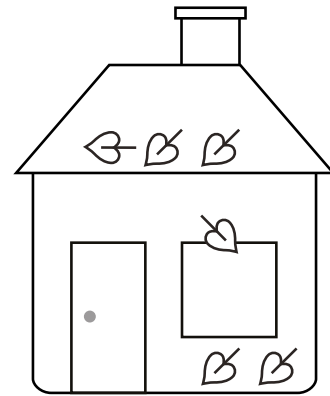

RUDENS MĒNEŠI IR:

DECEMBRIS	MARTS	JŪNIJS	SEPTEMBRIS
JANVĀRIS	APRĪLIS	JŪLIJS	OKTOBRIS
FEBRUĀRIS	MAIJS	AUGUSTS	NOVEMBRIS

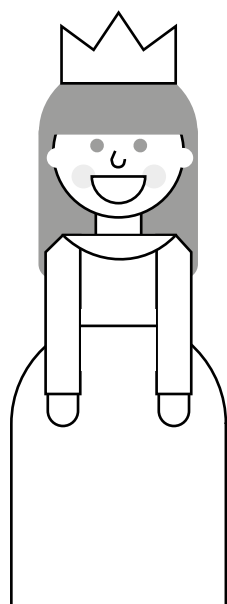

PRINCESE

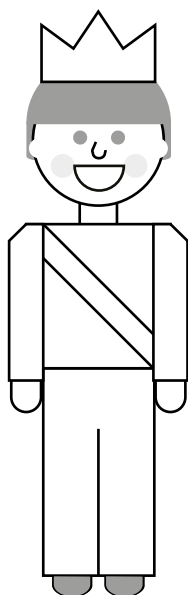

PRINCIS

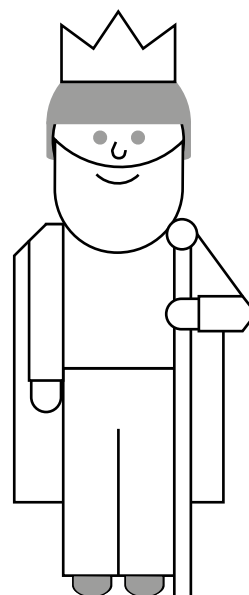

ĶĒNIŅŠ

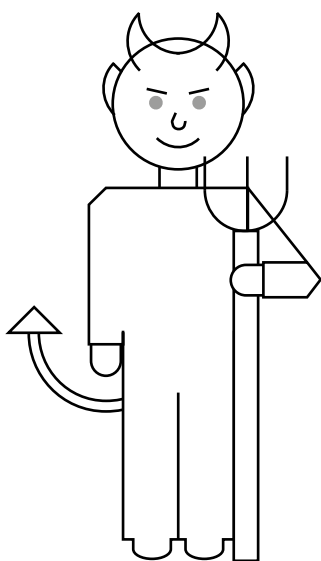

VELNS

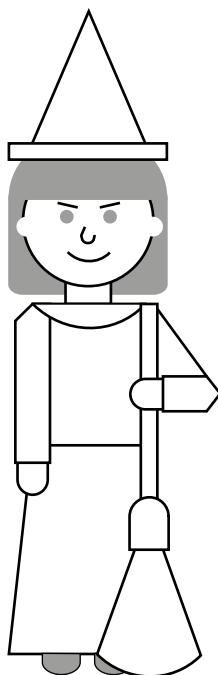

RAGANA

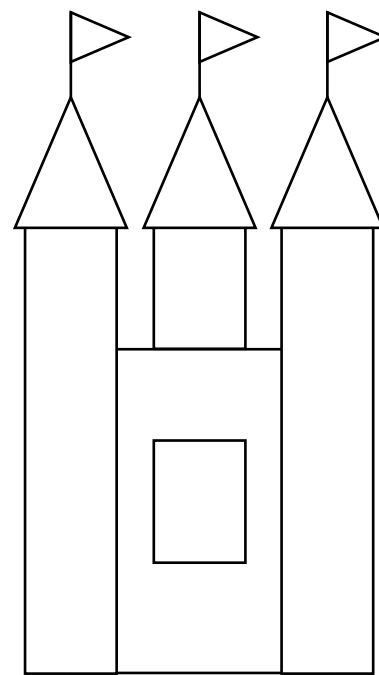

PILS

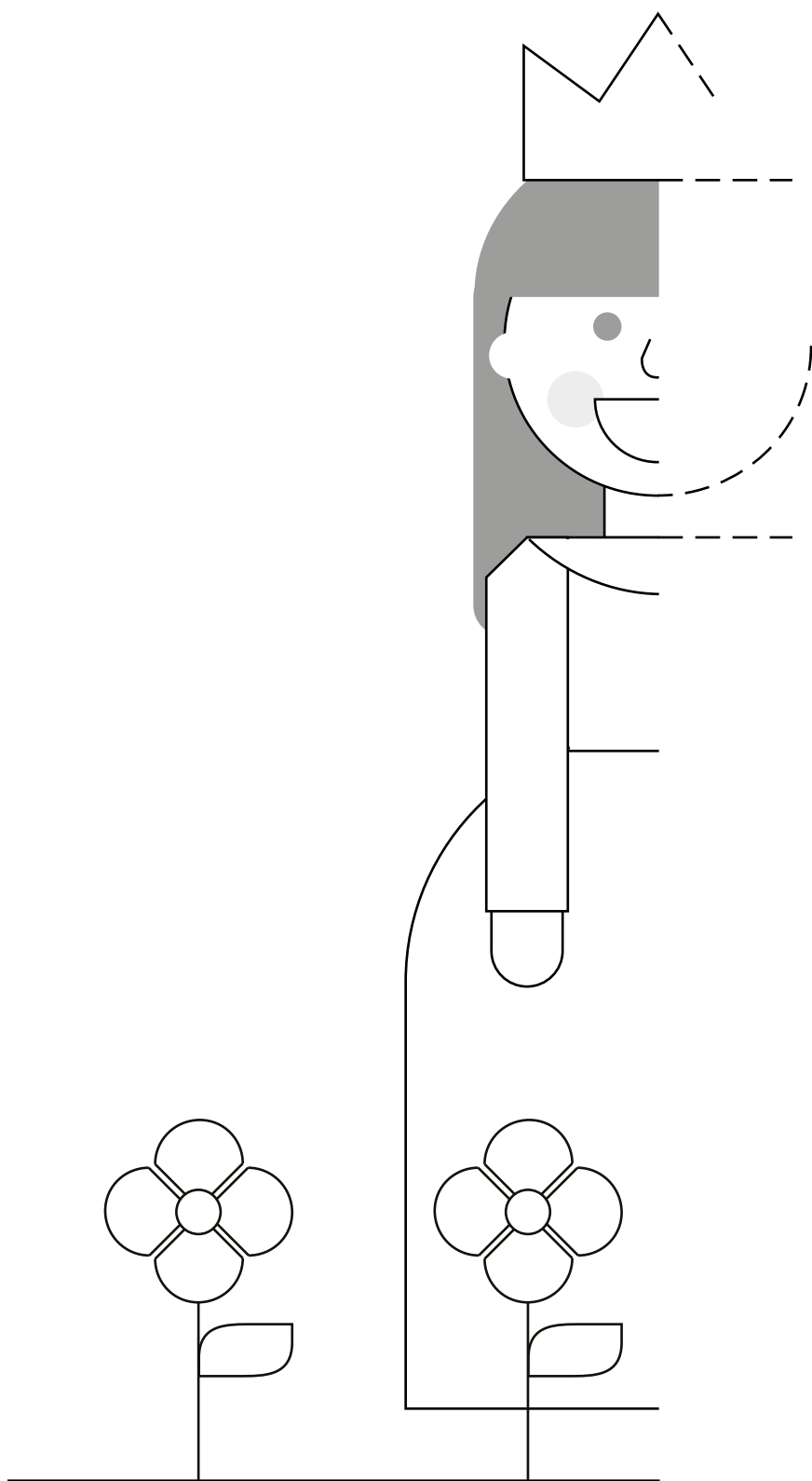

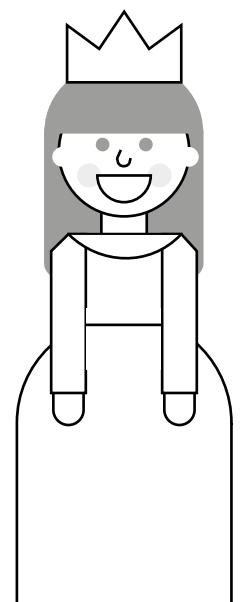
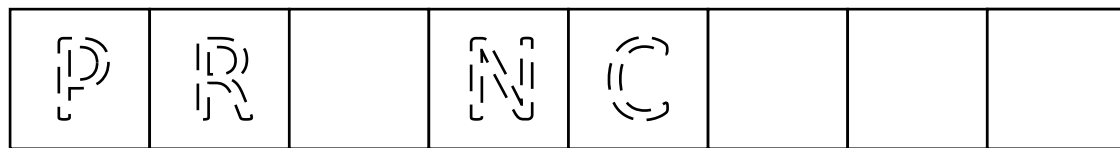
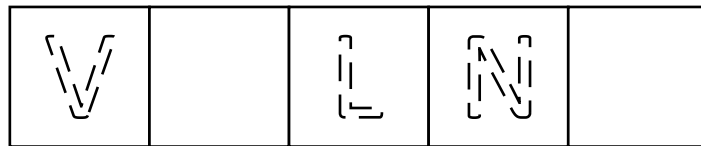
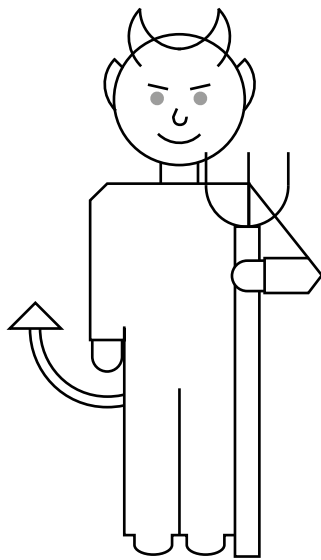
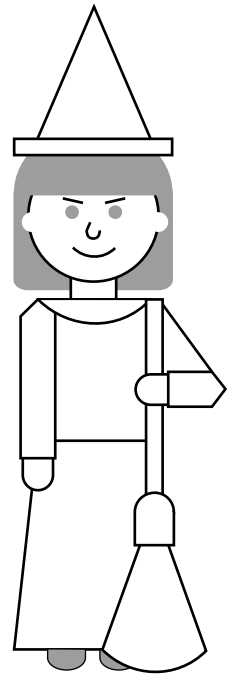
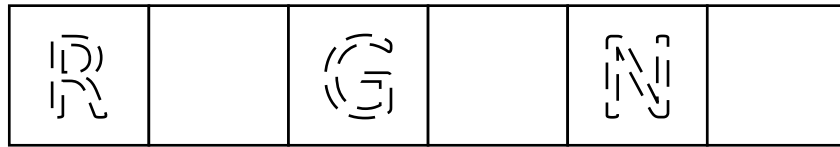
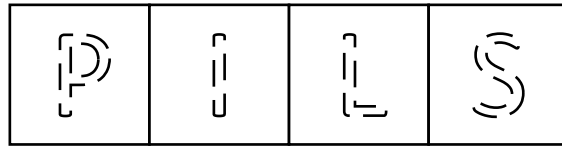
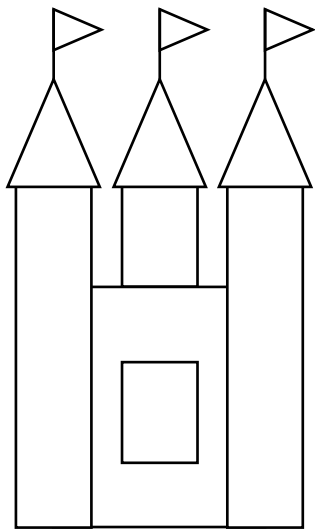

6. Garajos ziemas vakaros
6.1. Pasaku laiks

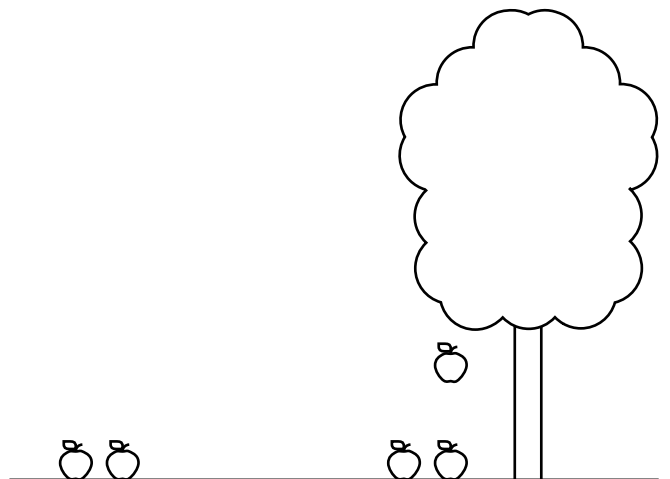
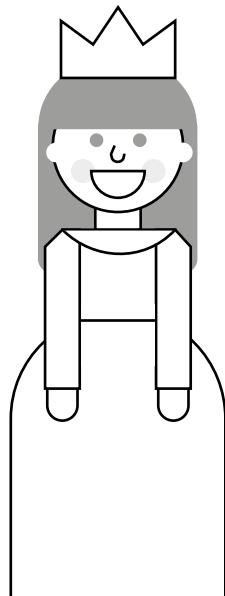
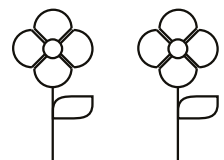
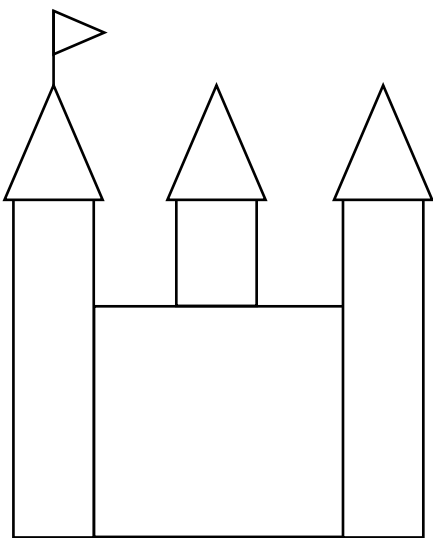
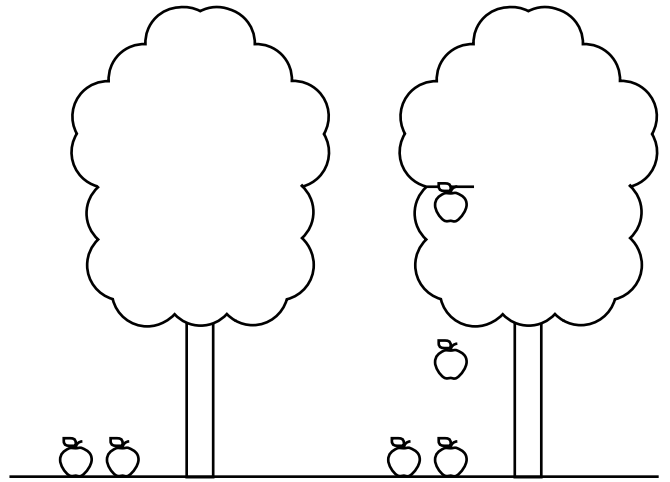
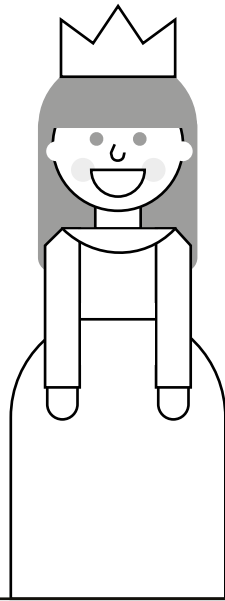
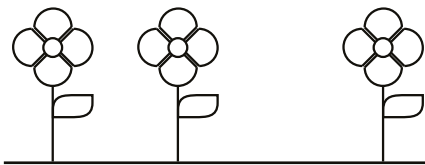
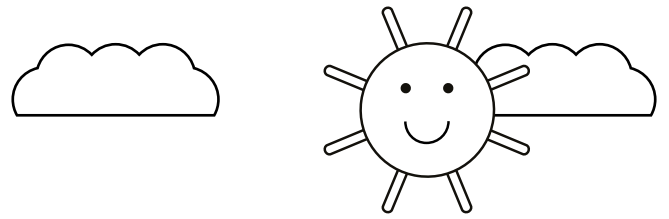
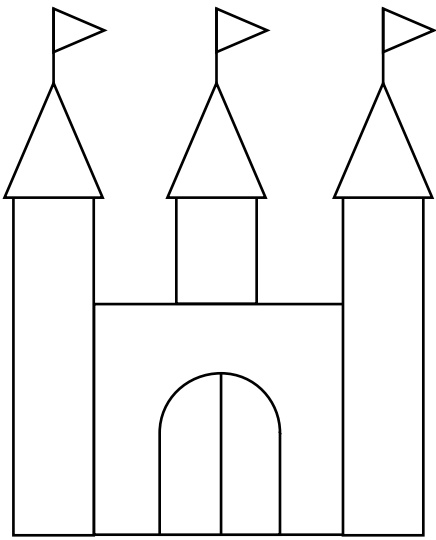

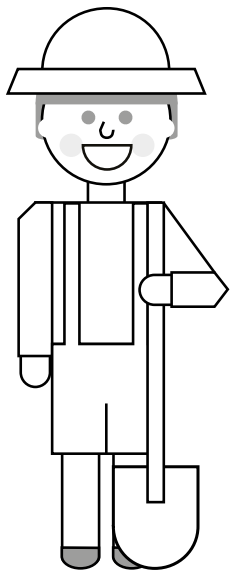

SPRĪDĪTIS

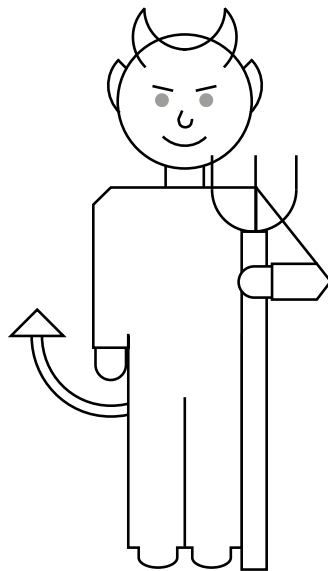

VELNS

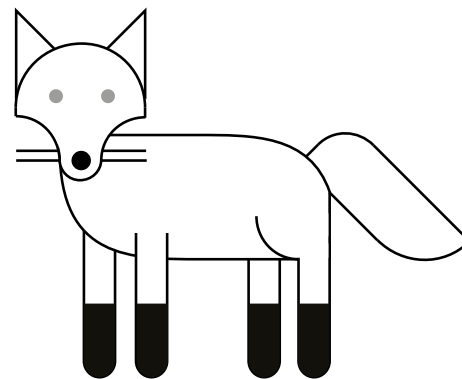

LAPSA

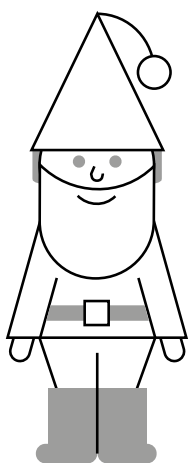

RŪKIS

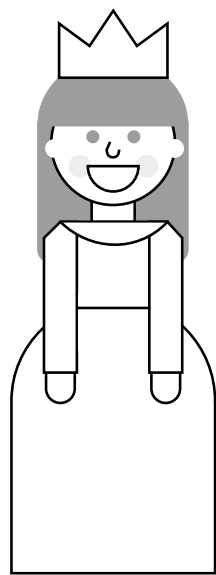

PRINCESE

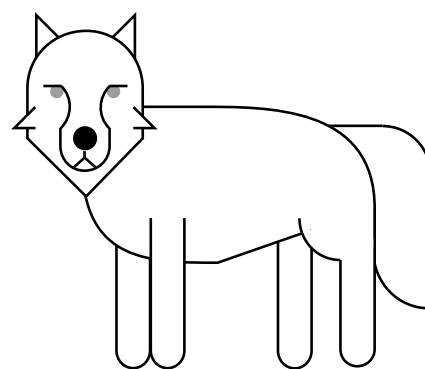

VILKS

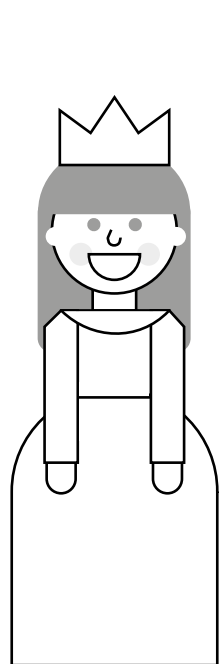

PRINCESE

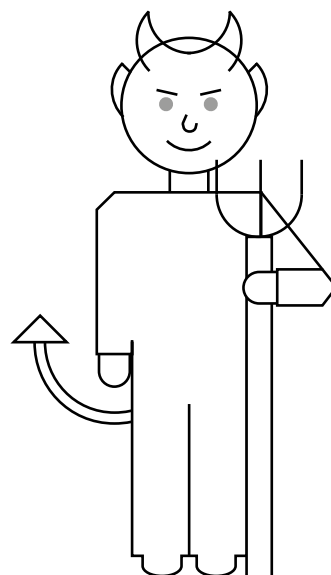

VELNS

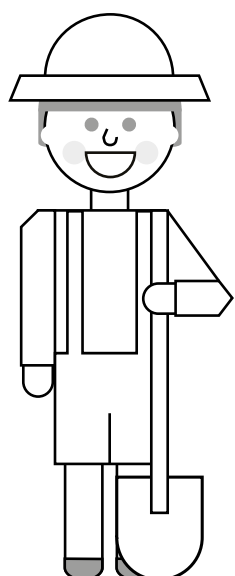

SPRĪDĪTIS

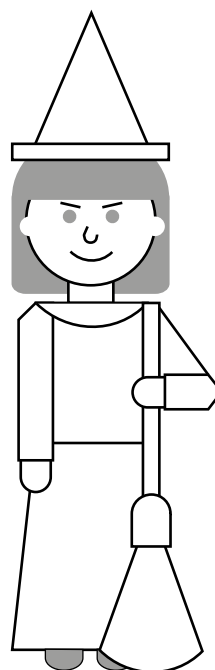
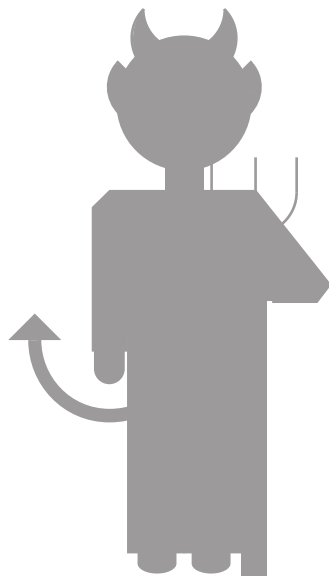

RAGANA

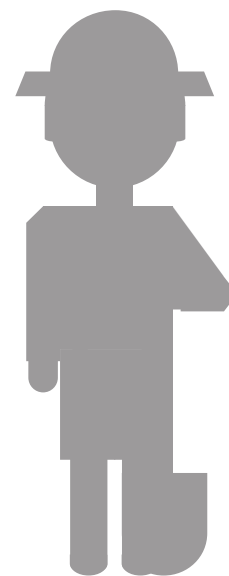



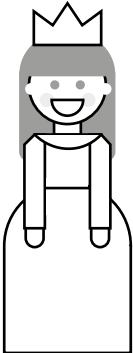
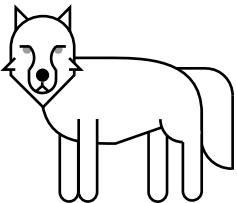
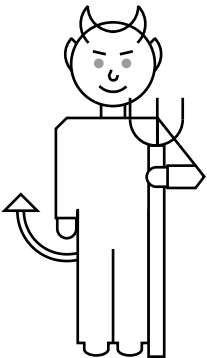
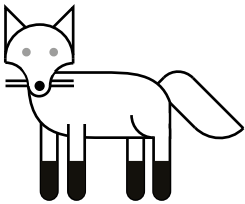
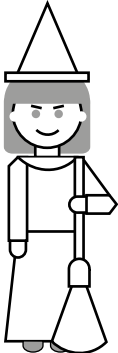

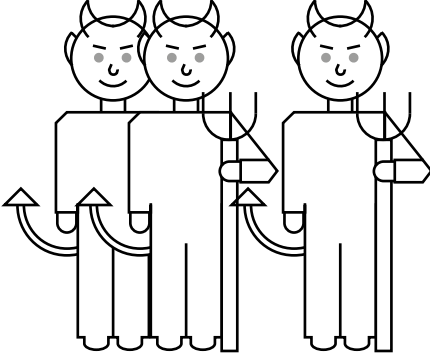
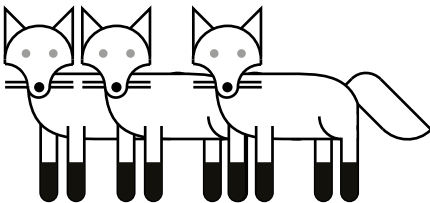
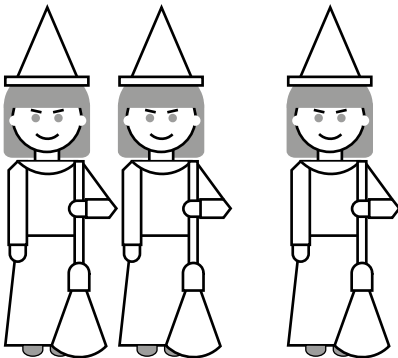
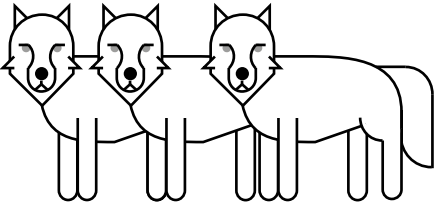
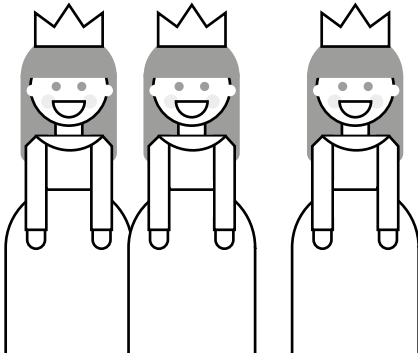
PRINCESE

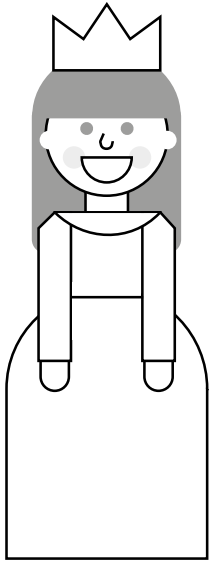
VILKS

VELNS

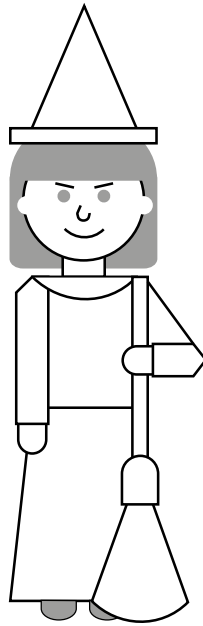
LAPSA

RAGANA



VELNI

LAPSAS

RAGANAS

VILKI

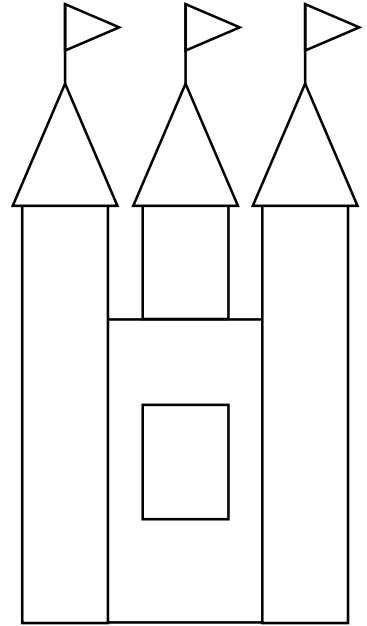
PRINCESES



SEPRINCE



GARANA



LSPI

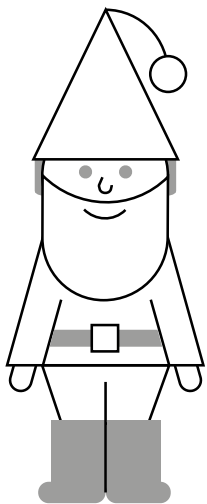

ĶISRŪ

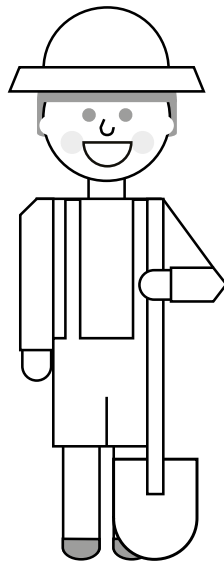

DĪSPRĪTIS

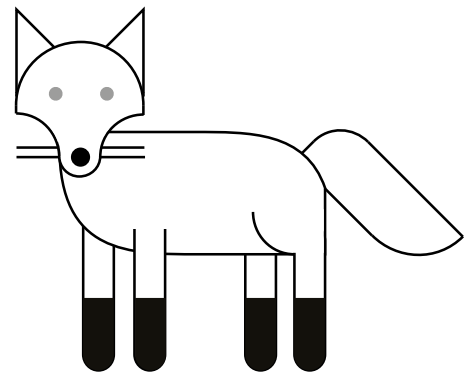

SALAP

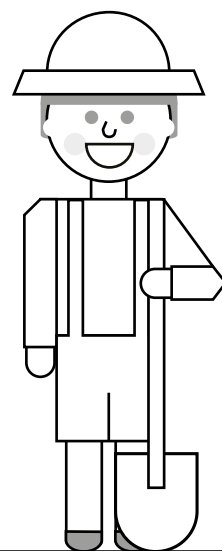
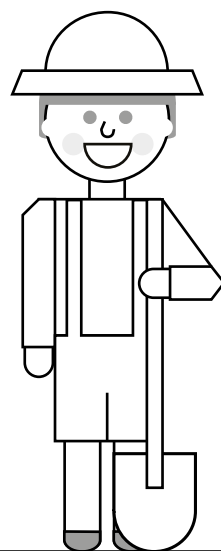
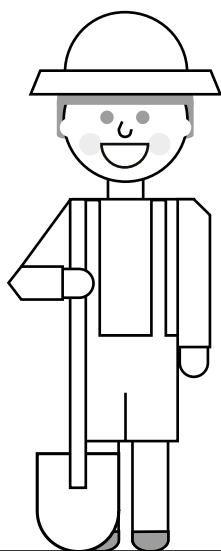
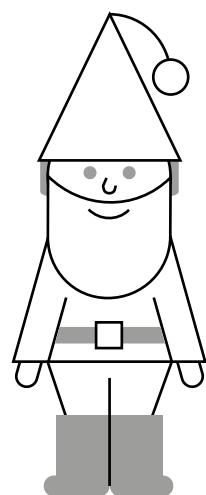
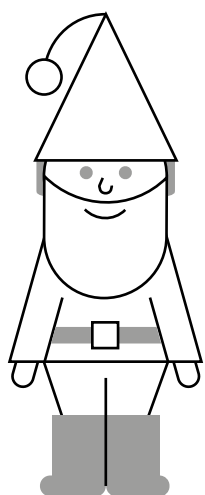
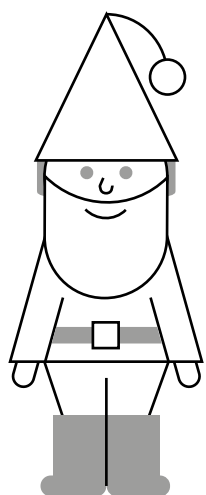
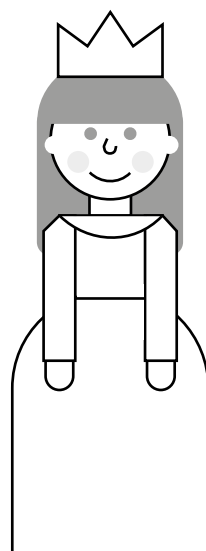
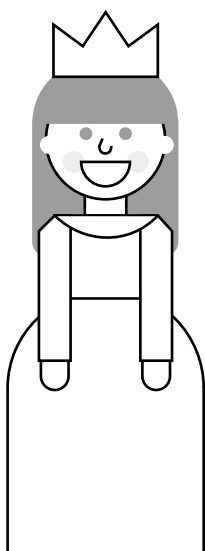
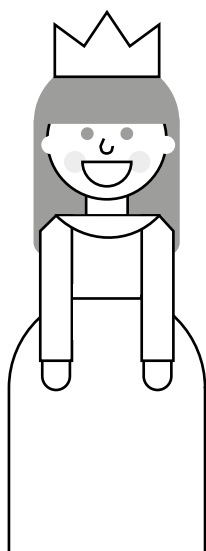

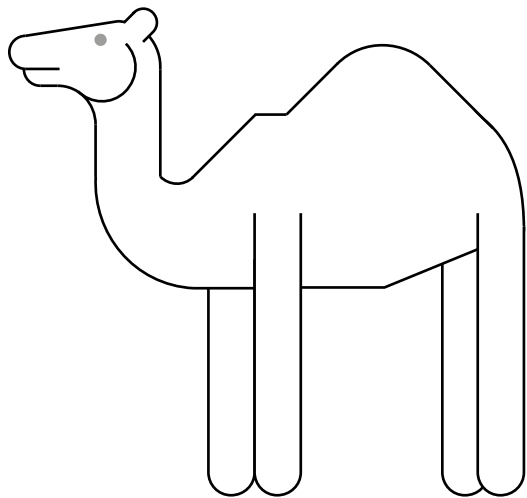

KAMIELIS

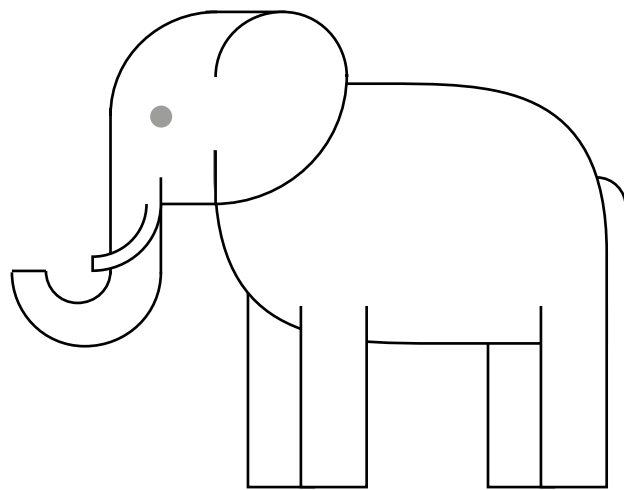

ZILONIS

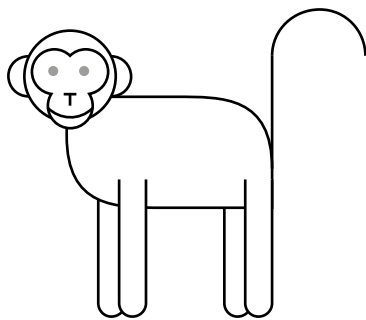

PĒRTIĶIS

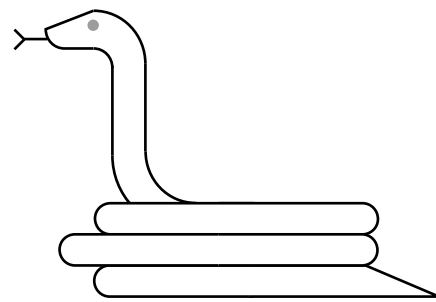
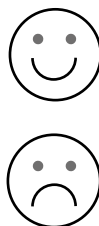

ČŪSKA

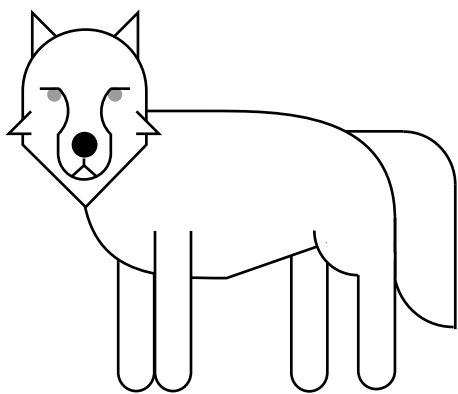

VILKS

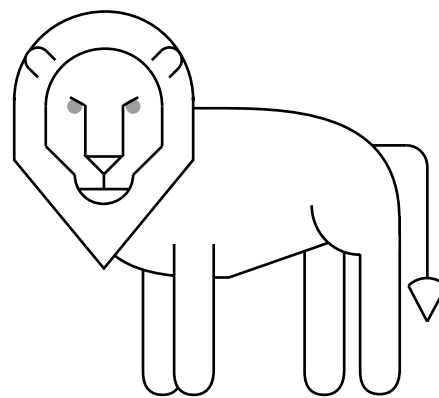

LAUVA

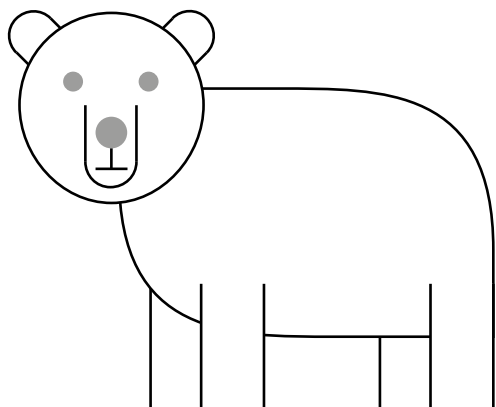

LĀCIS

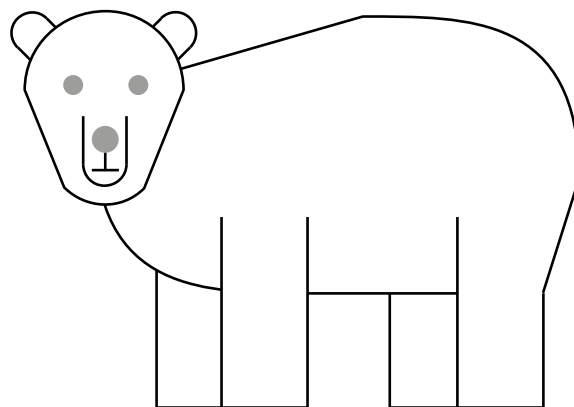

LEDUSLĀCIS

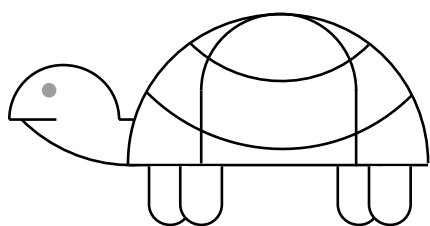

BRUŅURUPUCIS

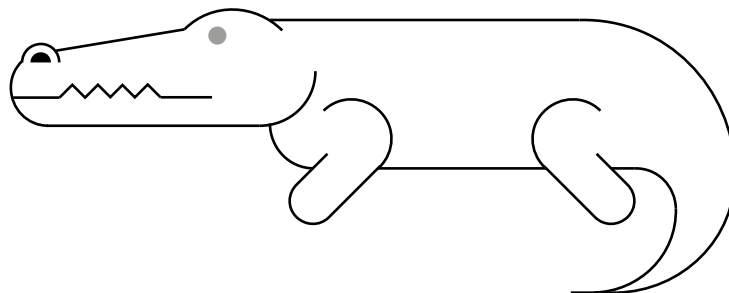

KROKODILS

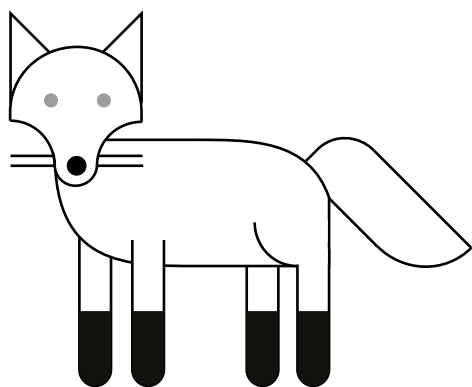

LAPSA

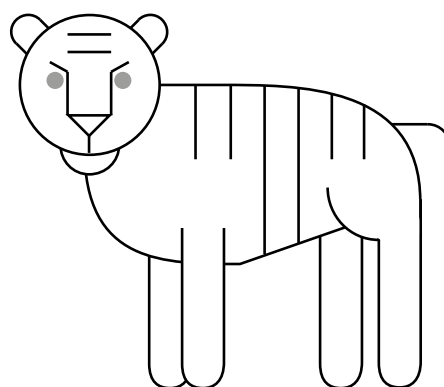

TĪĢERIS

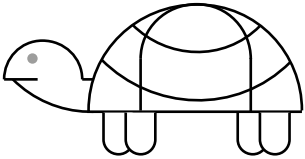
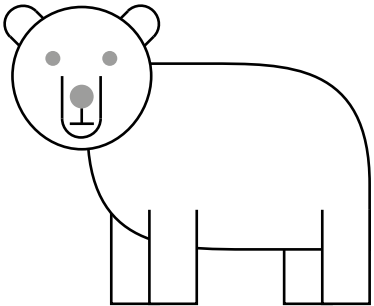
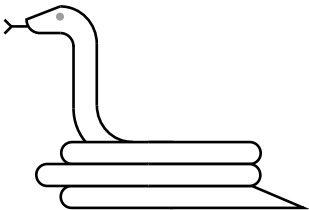
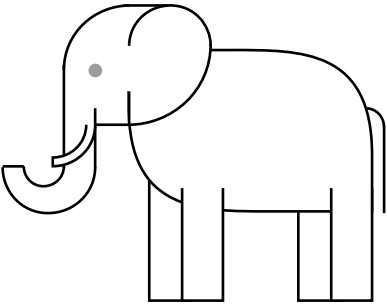
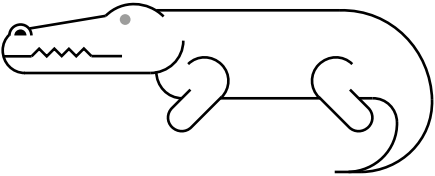

 BRUŅURUPUCIS
 LĀCIS
 ČŪSKA
 ZILONIS
 KROKODILS

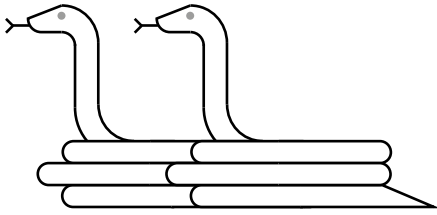
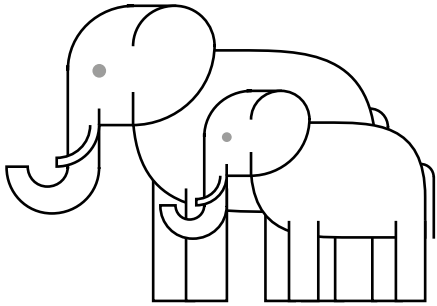
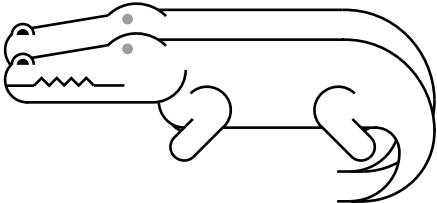
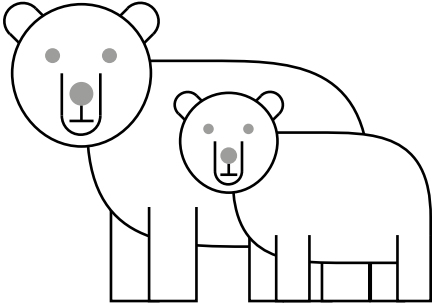
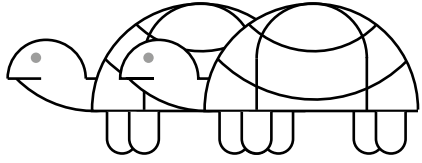
 ČŪSKAS
 ZILOŅI
 KROKODILI
 LĀČI
 BRUŅURUPUČI

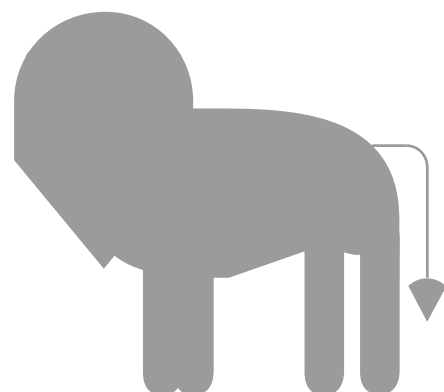
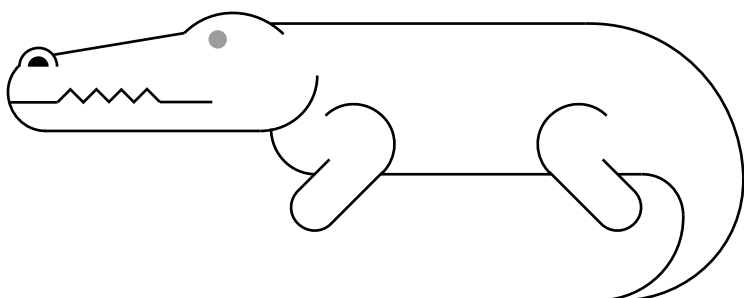
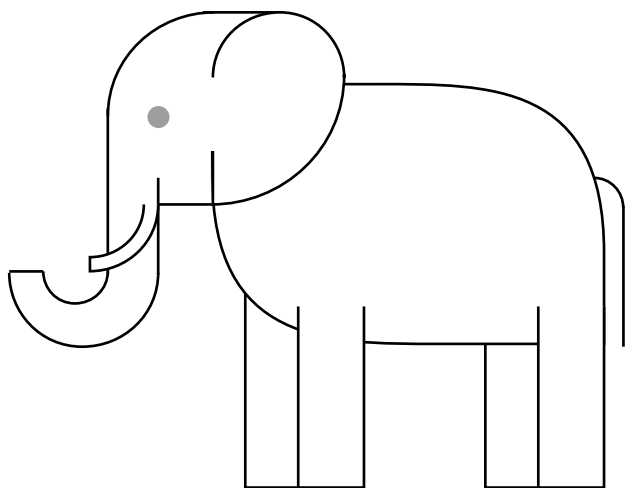
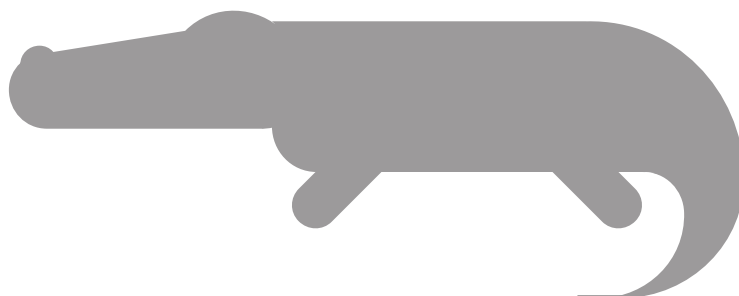
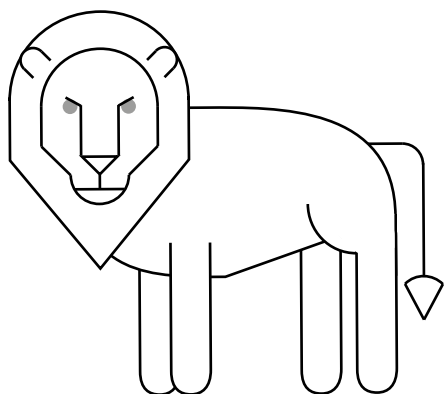
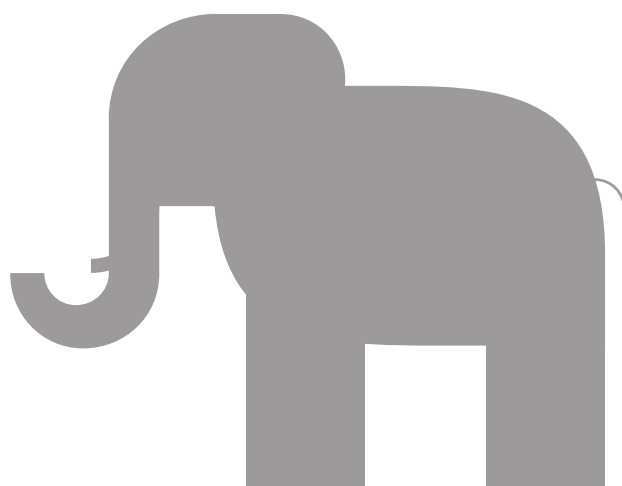
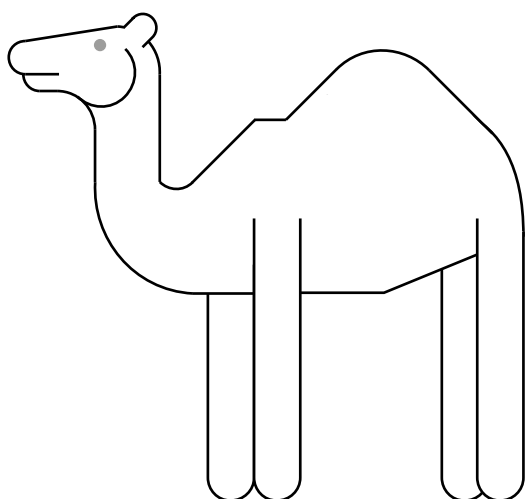

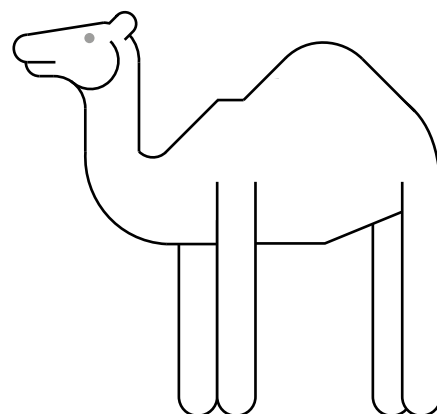
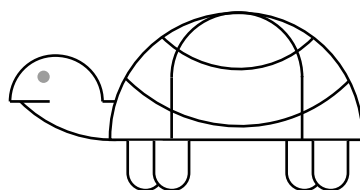
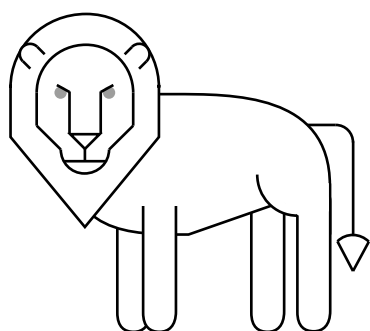
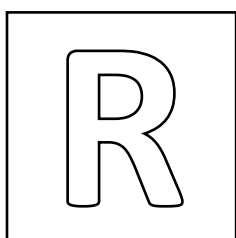
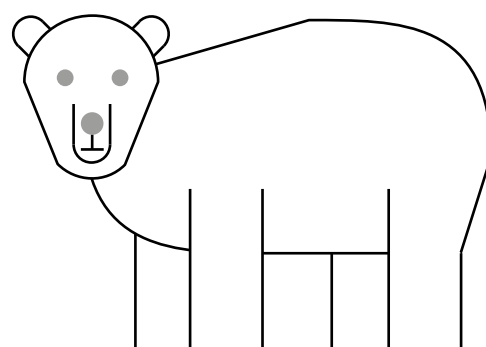
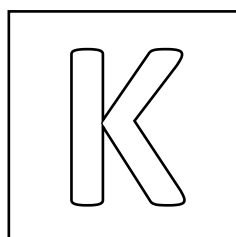
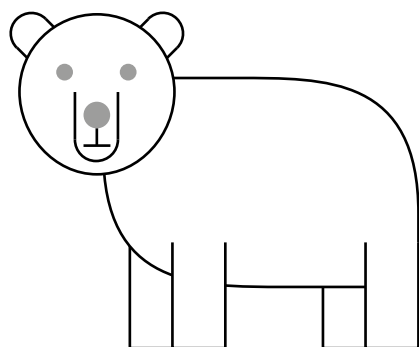
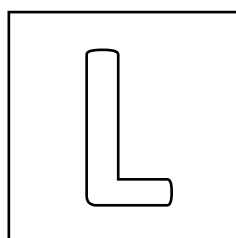
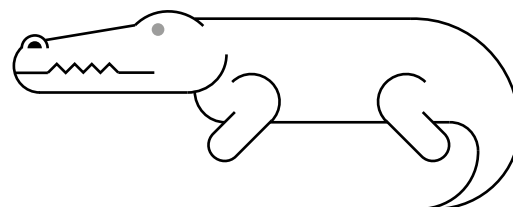
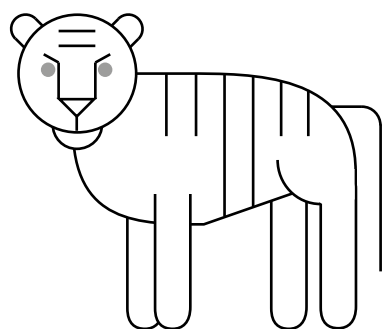

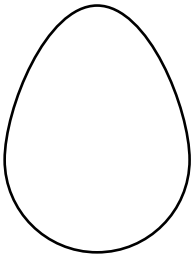
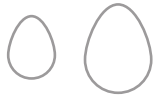

OLA

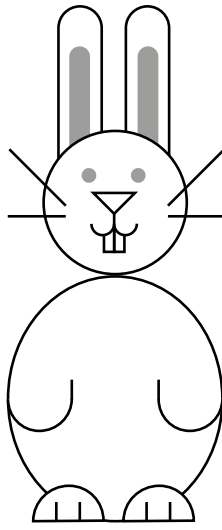

ZAKĪS

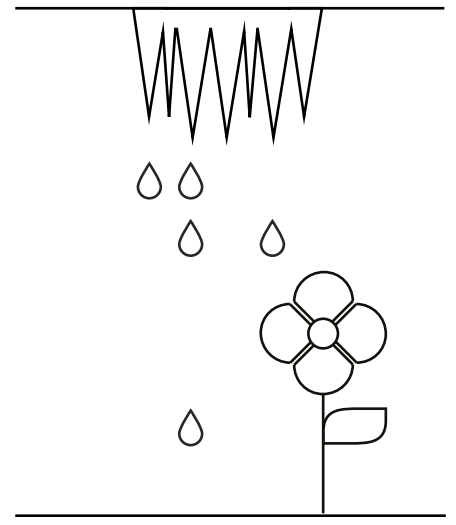

PAVASARIS

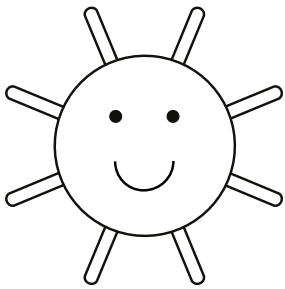

SAULE

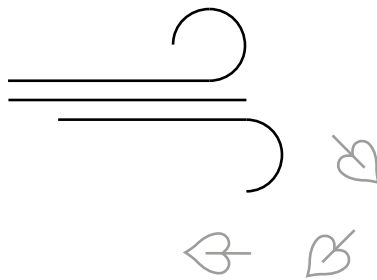

VĒJŠ

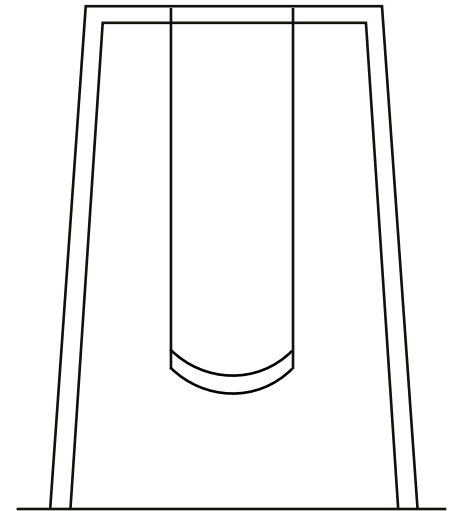

ŠŪPOLES

LIELDIENAS

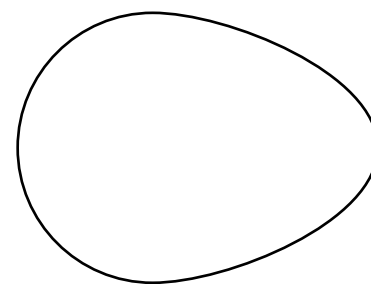
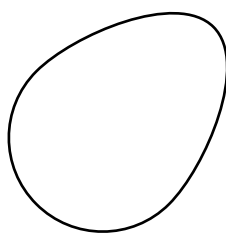
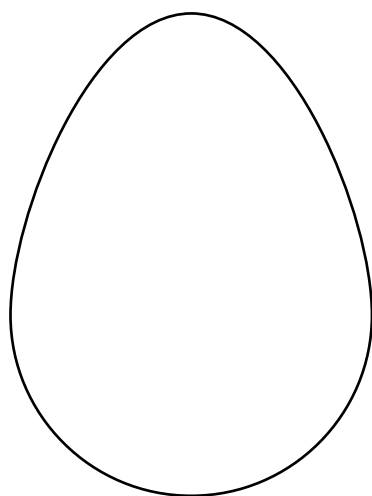
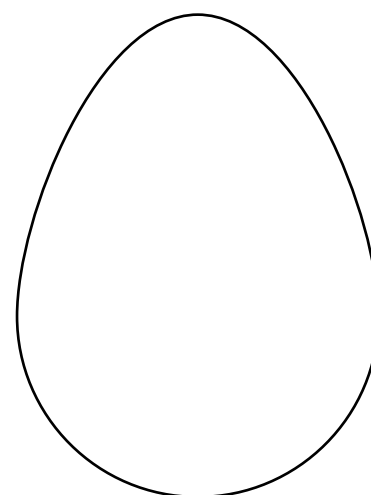
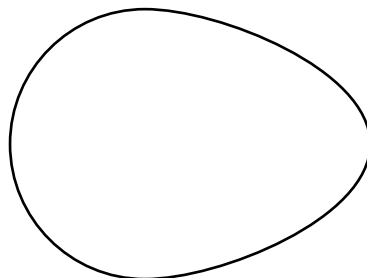
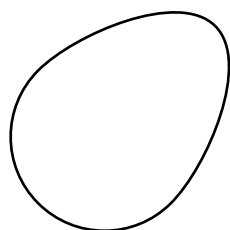
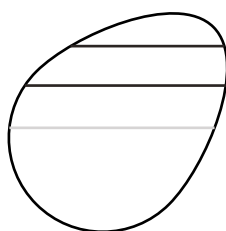
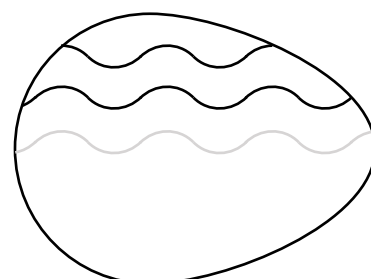
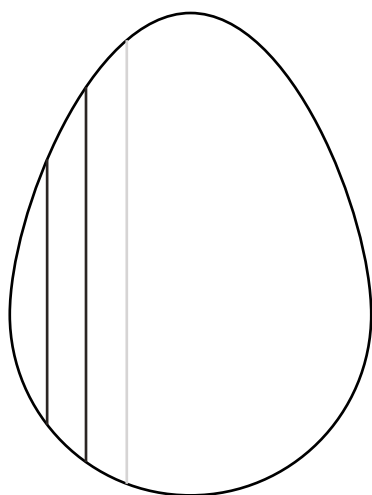

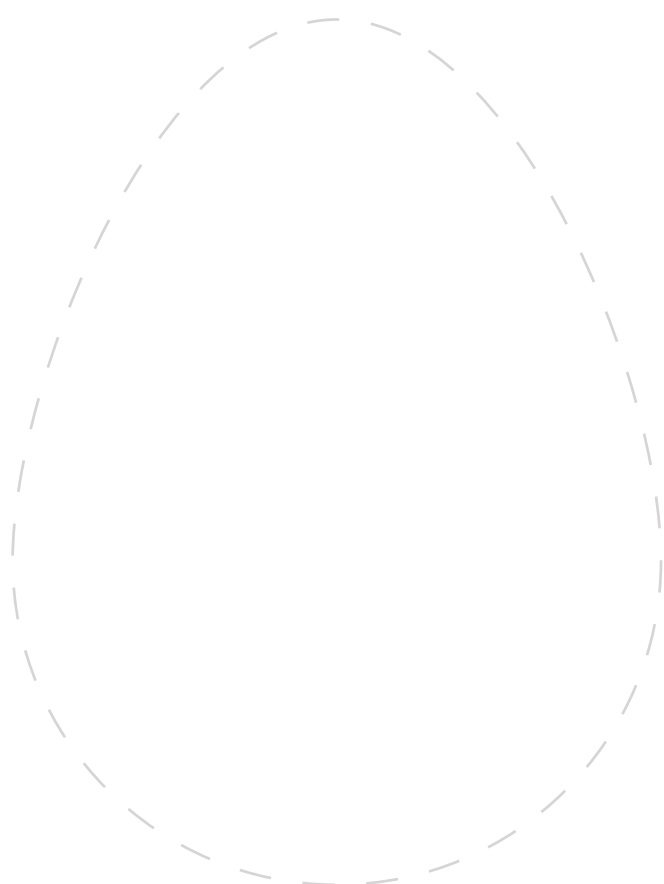
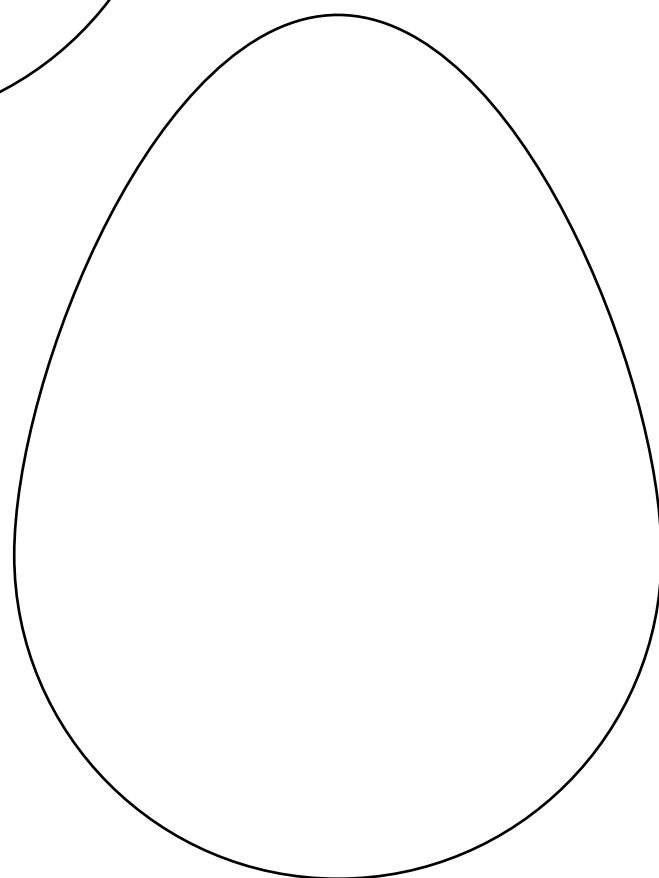
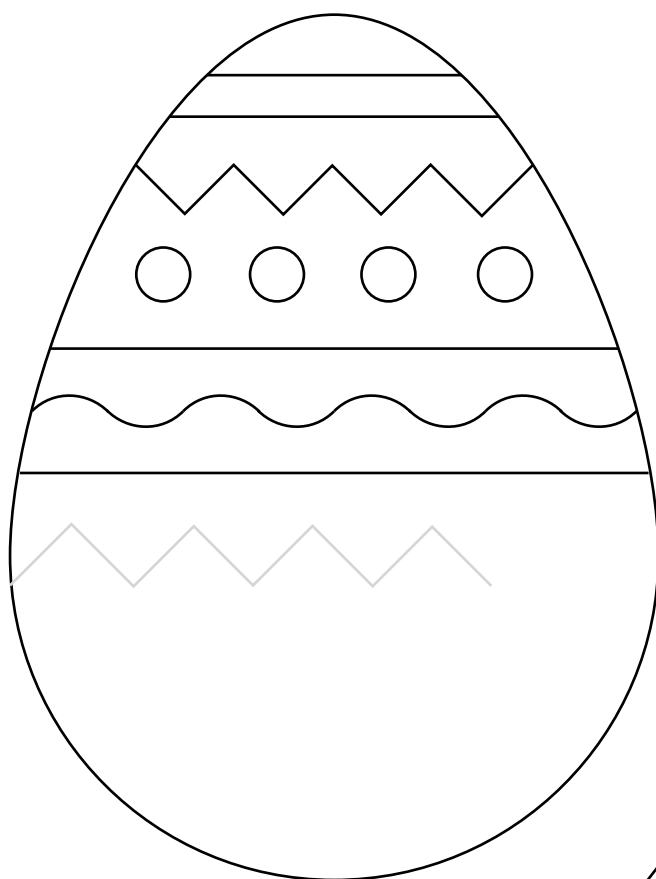

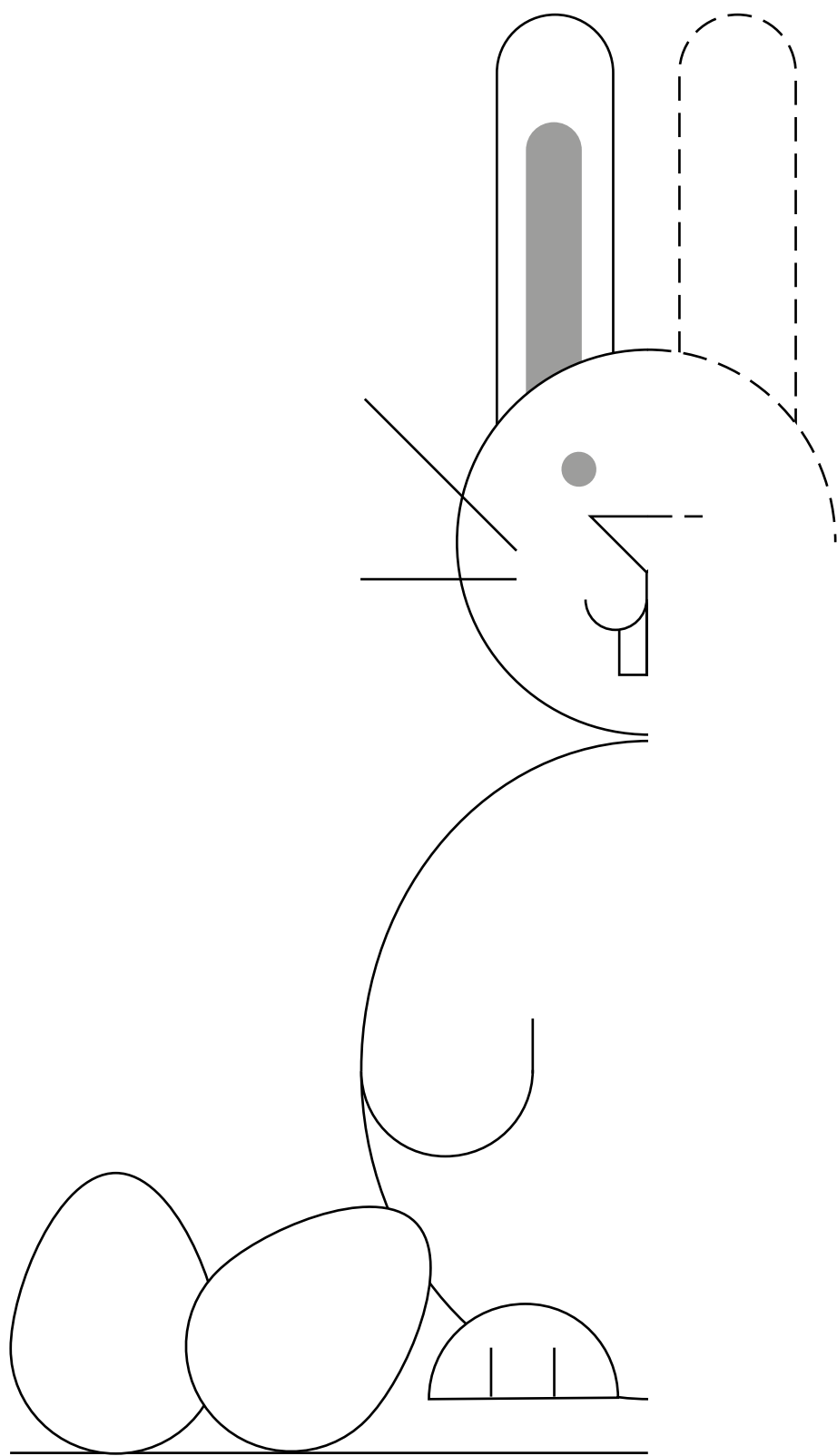

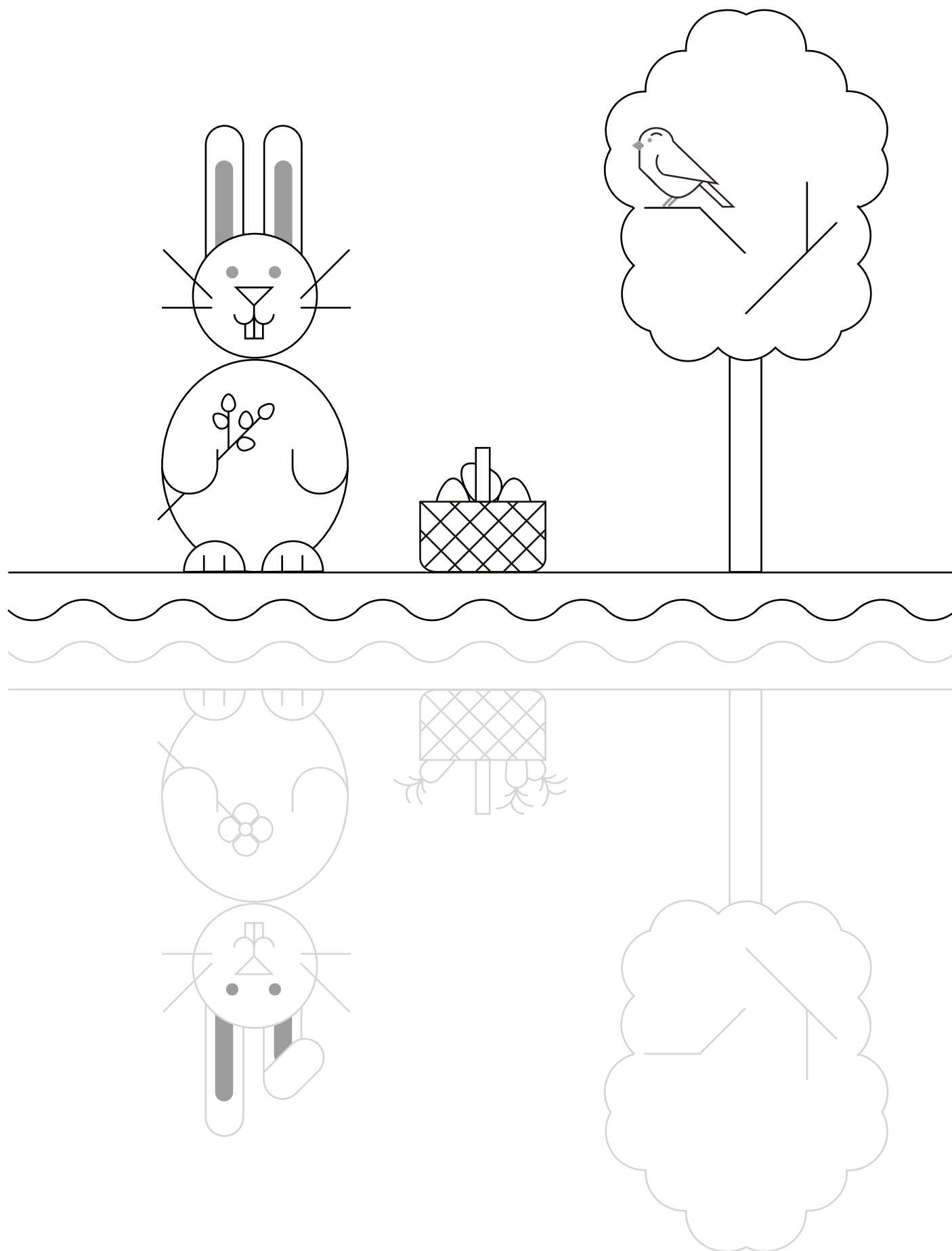



8.1. Visas bučas mammai

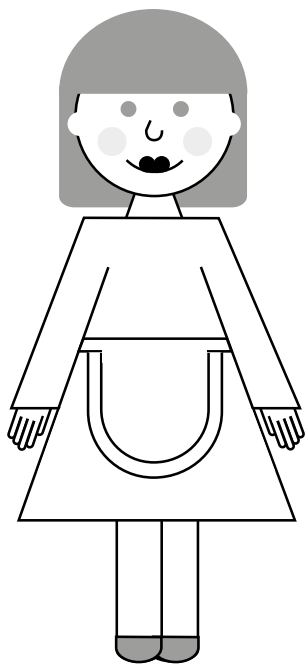

MAMMA

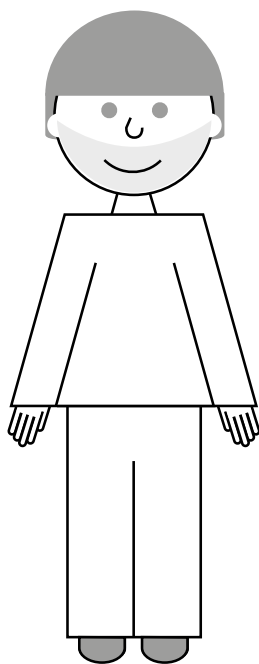

TĒTIS

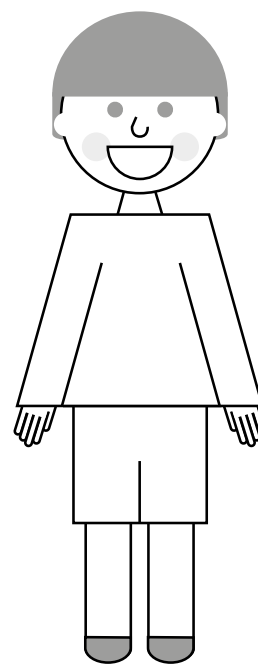

BRĀLIS

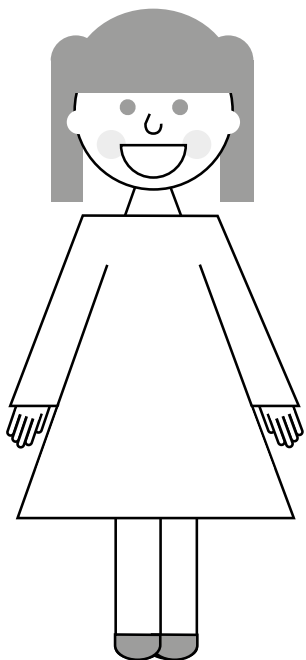

MĀSA

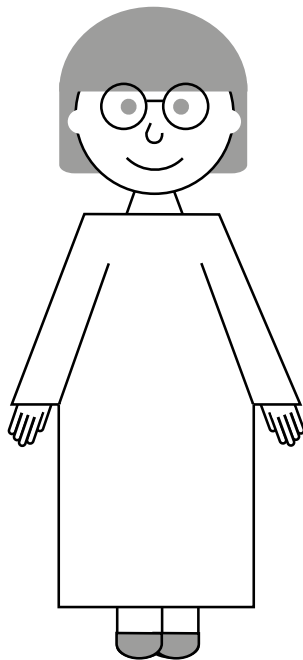

VECMĀMIŅA

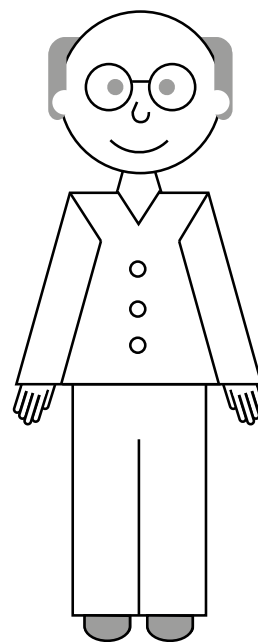

VECTĒTIŅŠ

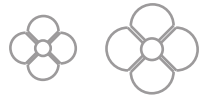

MANS VĀRDS IR _____

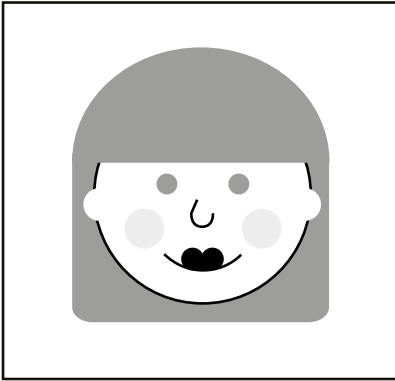

SAUC _____

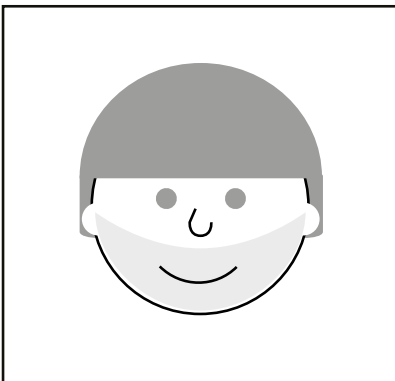

SAUC _____

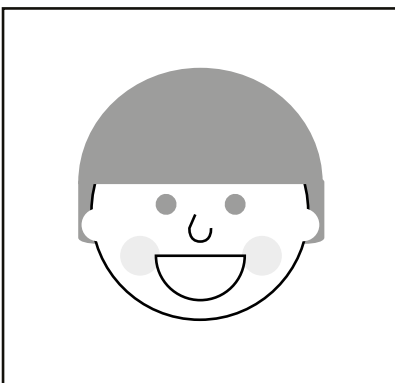

SAUC _____

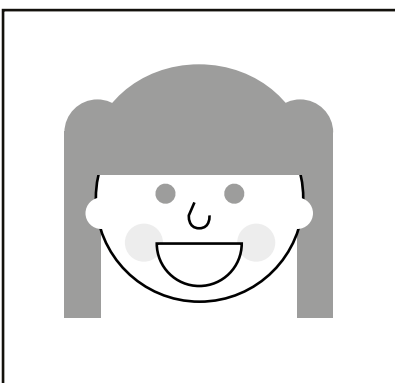

SAUC _____



MAN

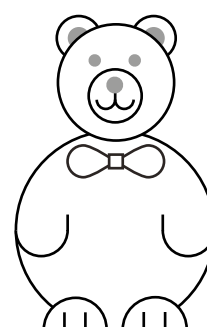
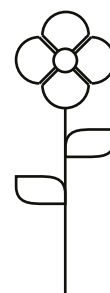
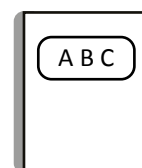
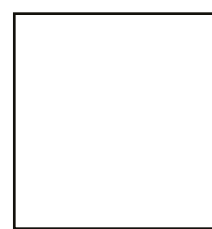
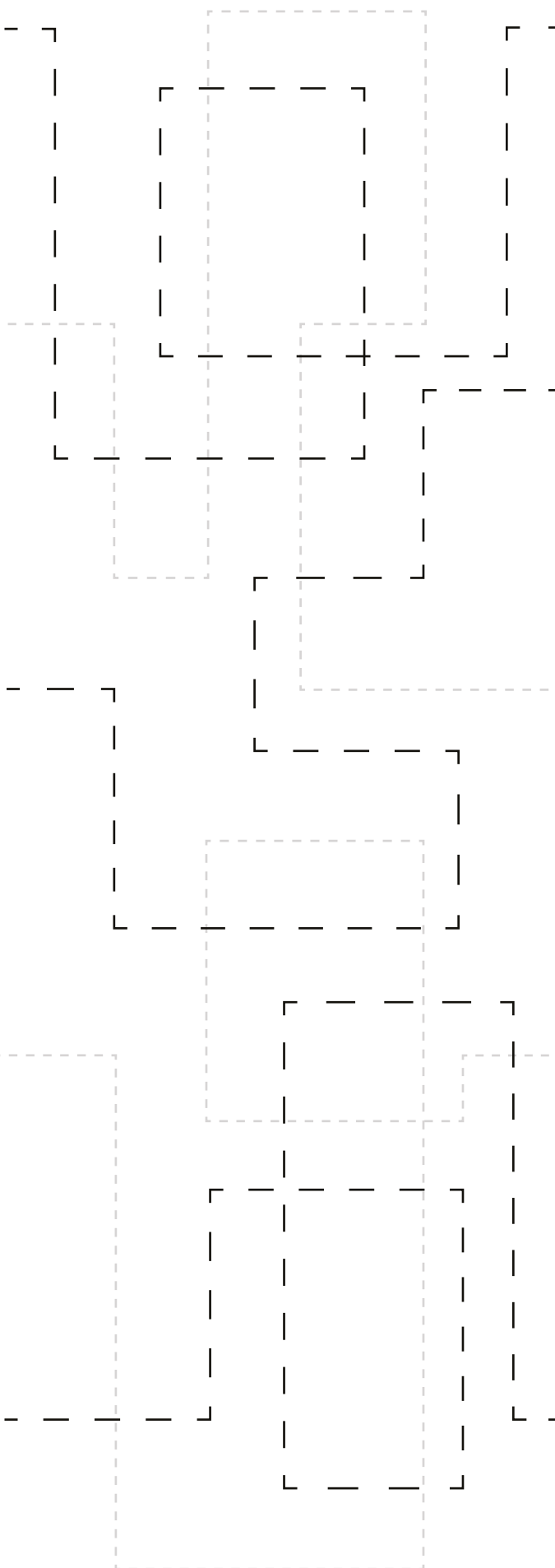
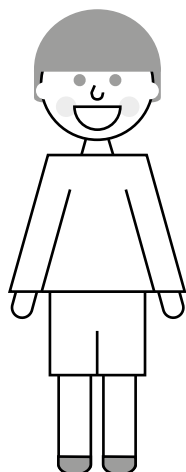
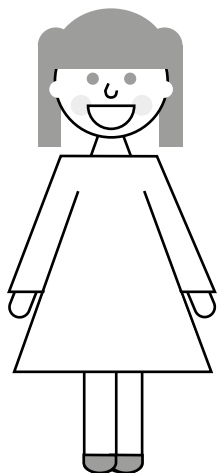
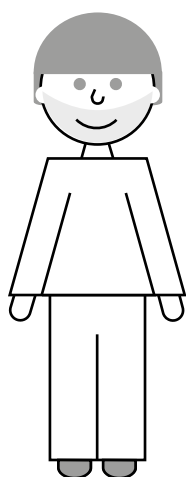
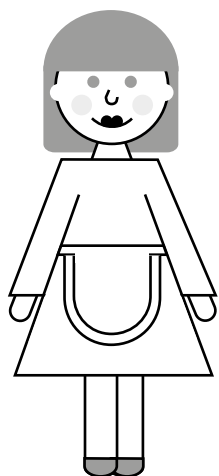

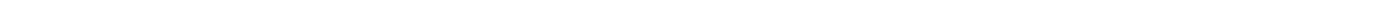
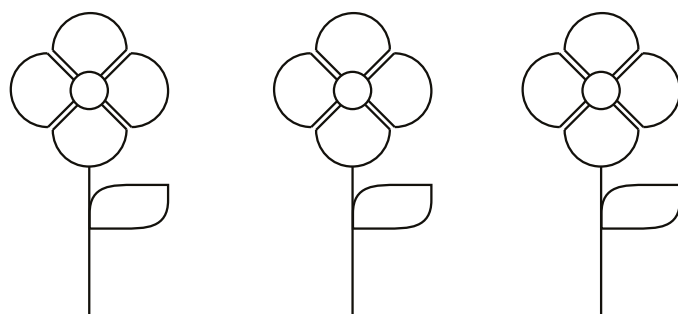
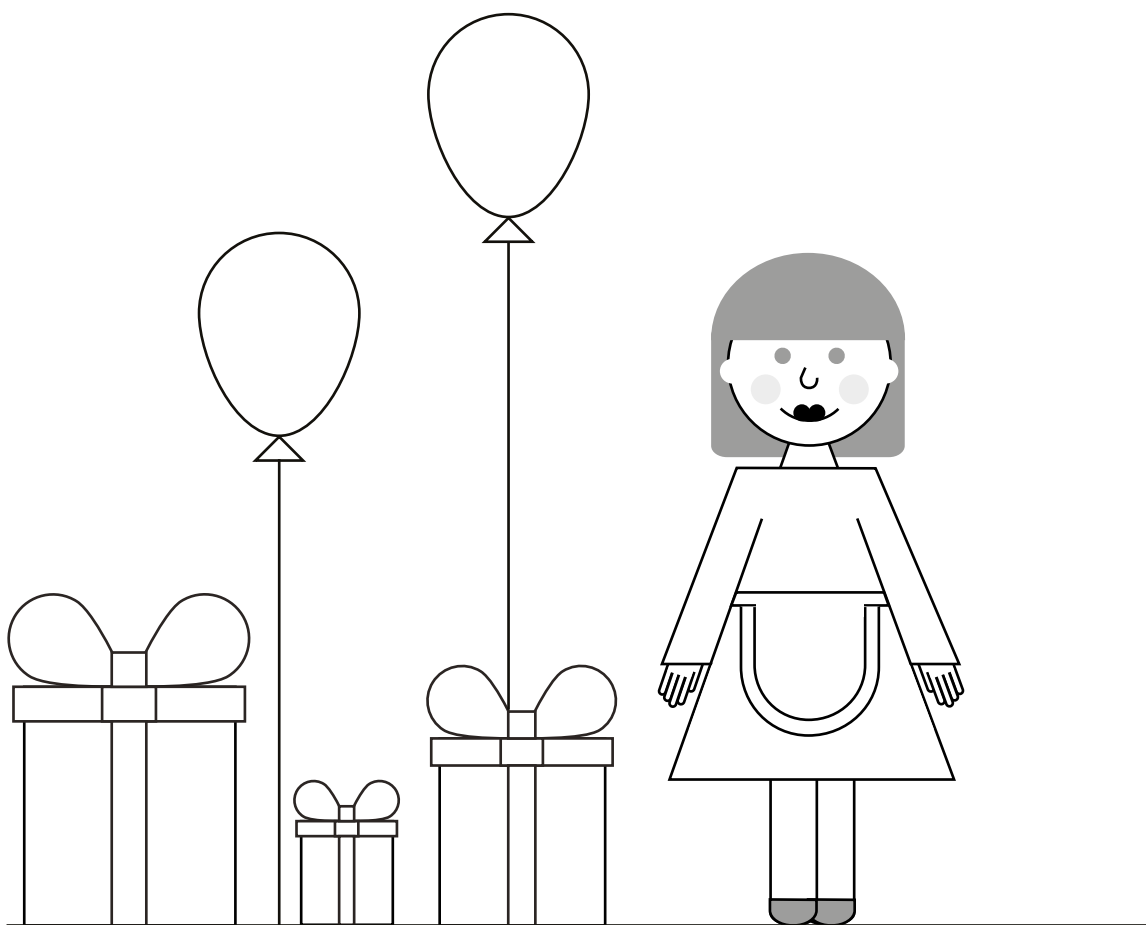
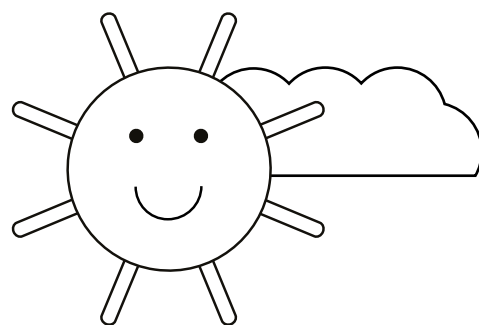
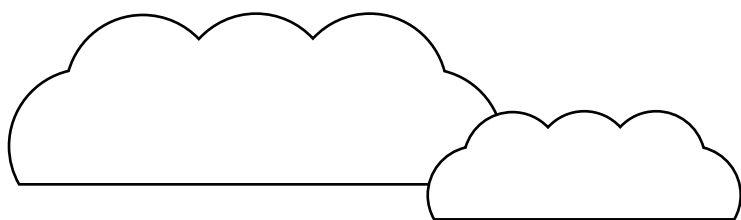

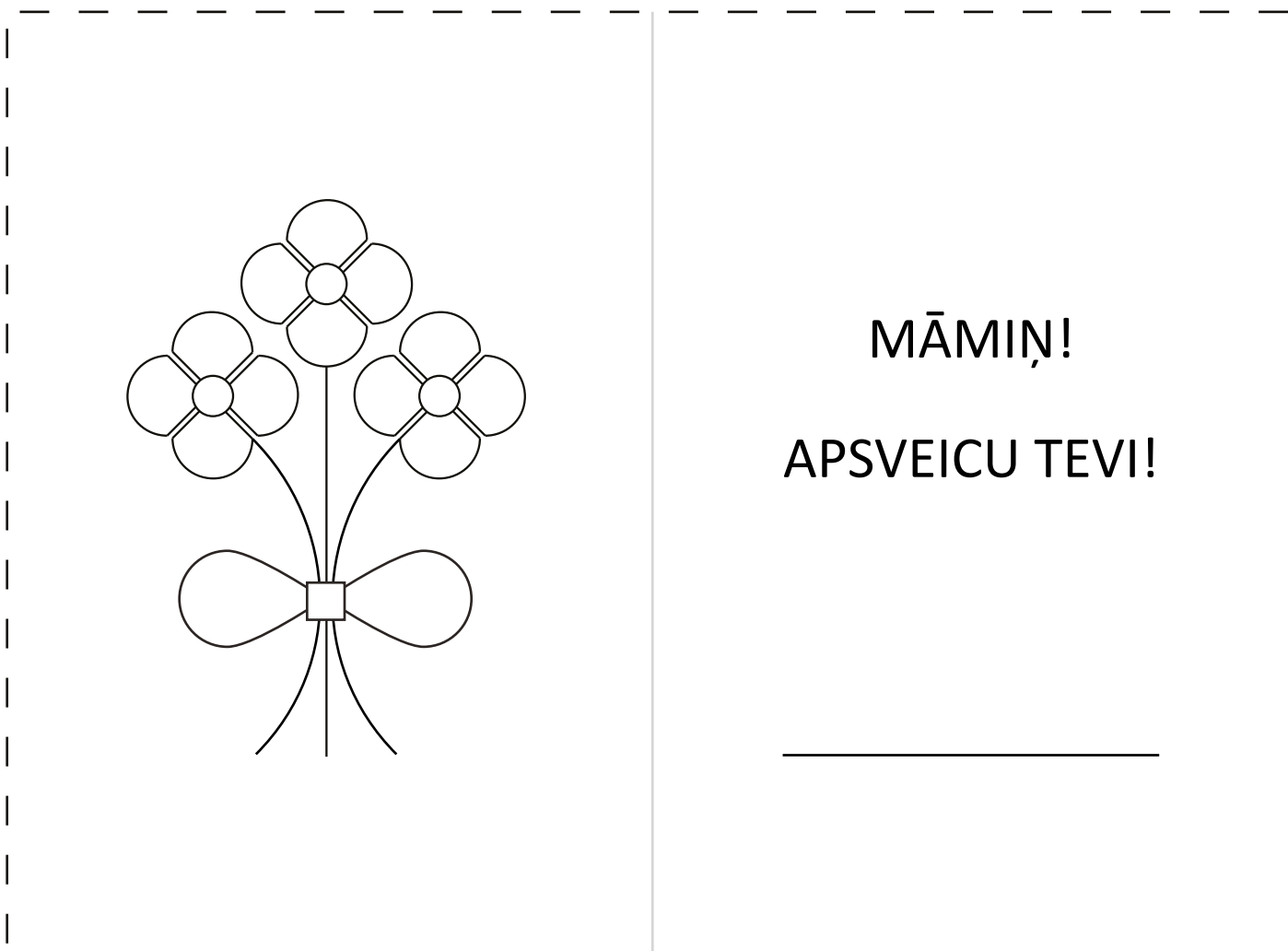
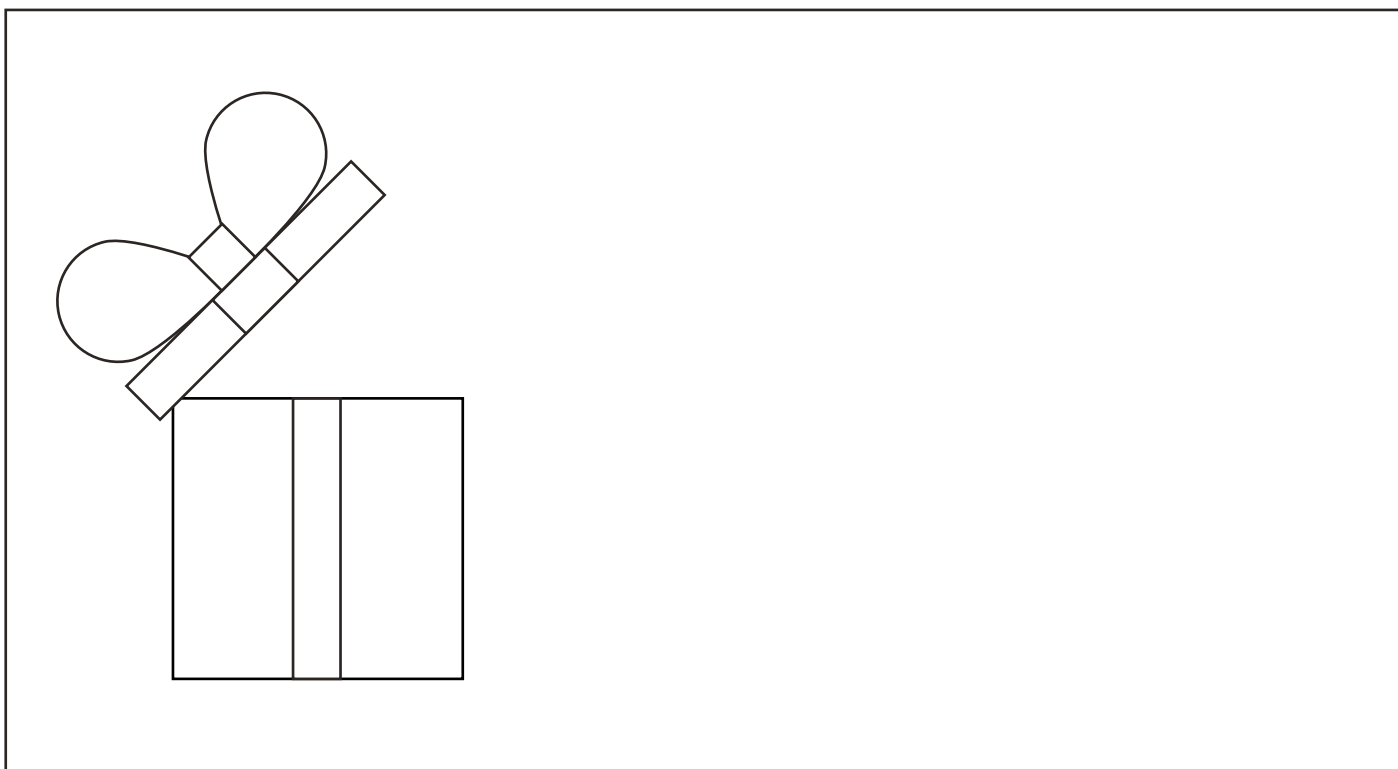

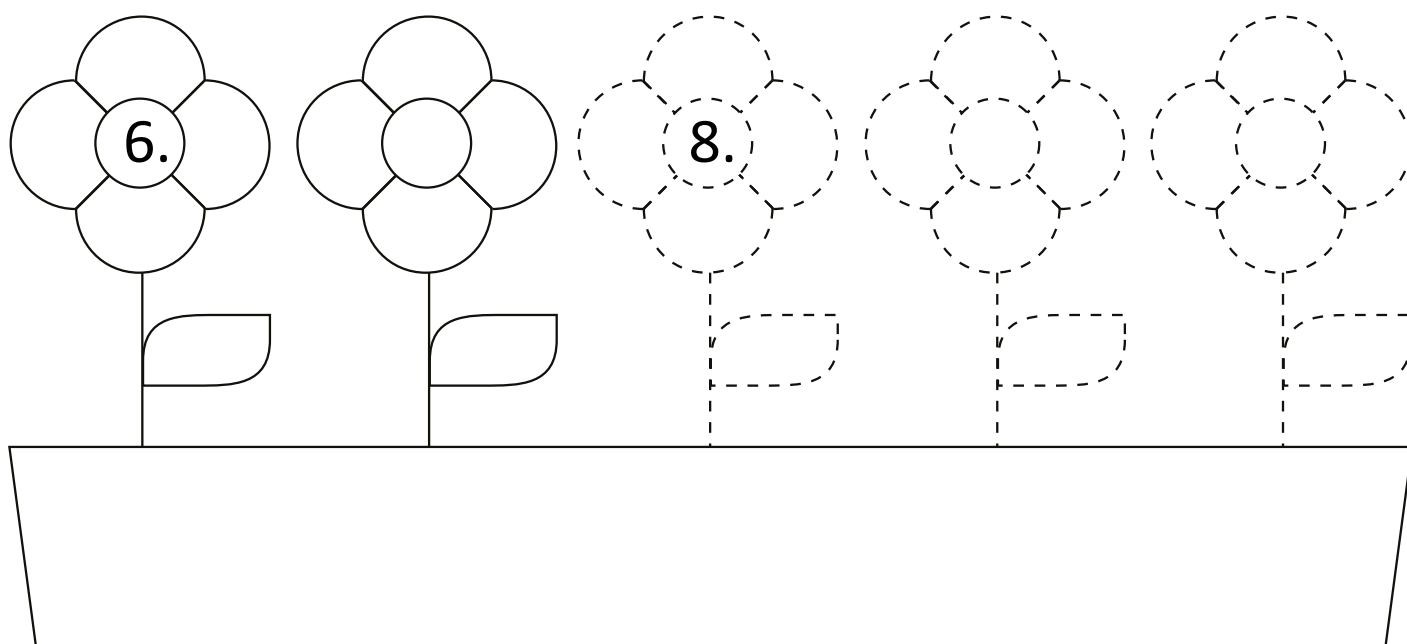
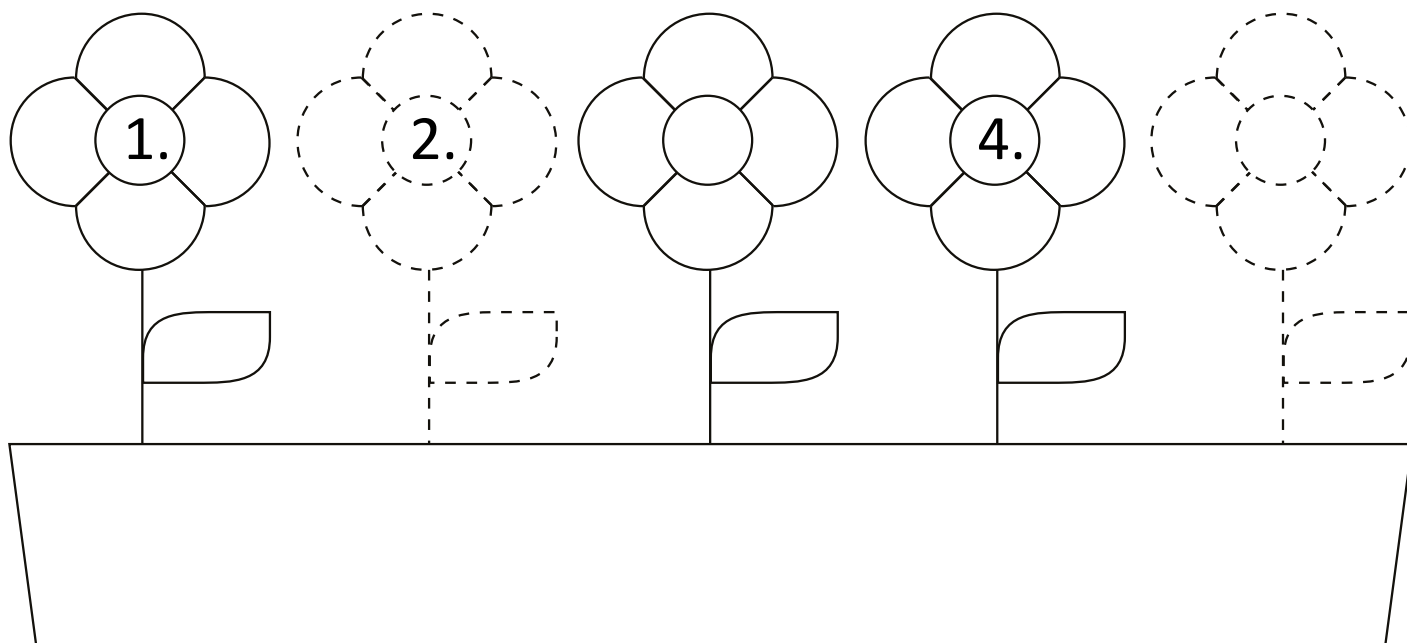

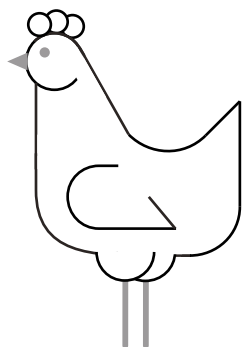

VISTA

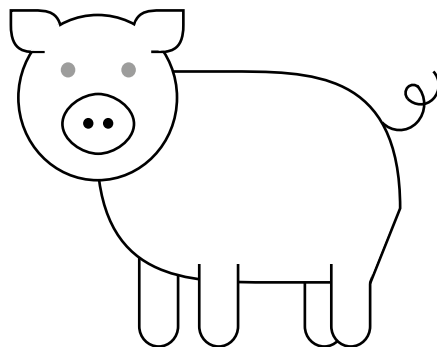

CŪKA

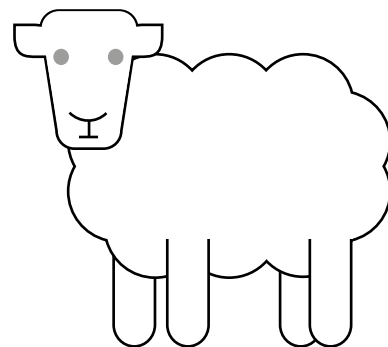

AITA

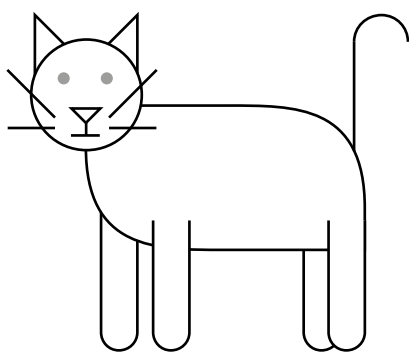

KAĶIS

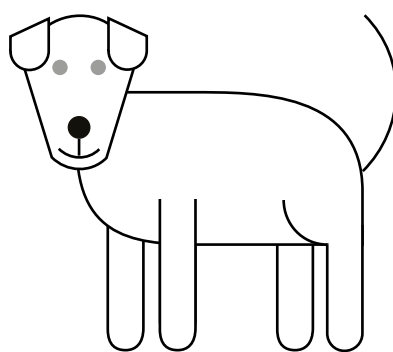

SUNS

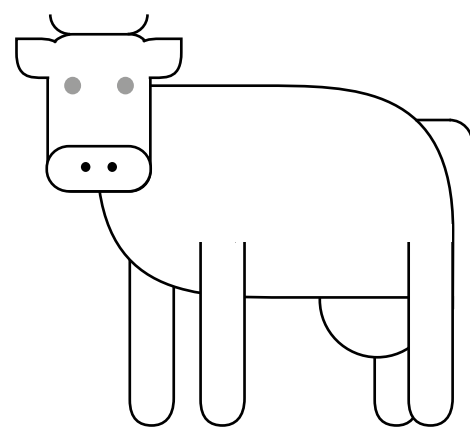

GOVS

